

EVOLVE ENERGY GROUP CO., LIMITED

TEST REPORT

SCOPE OF WORK

EMC TESTING– SEE PAGE 2

REPORT NUMBER

200521129GZU-001

ISSUE DATE

16-June-2020

[REVISED DATE]

[-----]

PAGES

58

DOCUMENT CONTROL NUMBER

EN 61000-6-1, 6-3-b

© 2017 INTERTEK



TEST REPORT

Telephone: 86-20-8213 9688

Facsimile: 86-20-3205 7538

www.intertek.com

Applicant Name & : EVOLVE ENERGY GROUP CO., LIMITED
Address : RM 702, 7/F FU FAI COMM CTR 27 HILLIER ST SHEUNG WAN, HK
Manufacturing Site : Same as applicant
Intertek Report No: 200521129GZU-001

Test standards

EN 61000-6-1:2007 (IEC 61000-6-1:2005)

EN 61000-6-3:2007+A1:2011(IEC 61000-6-3:2006+A1:2010)

Sample Description

Product : Solar Grid Tied Inverter
Model No. : EVVO 3000TL3P, EVVO 4000TL3P, EVVO 4800TL3P,
EVVO 5000TL3P, EVVO 6000TL3P, EVVO 8000TL3P,
EVVO 10000TL3P, EVVO 12000TL3P
Electrical Rating : See page 6
Serial No. : Not Labeled
Date Received : 02 November 2019
Date Test : 04 November 2019-07 November 2019
Conducted

Prepared and Checked By

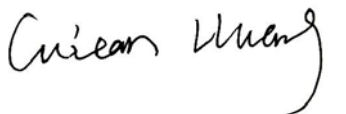

Guitar Huang

Project Engineer

Intertek Guangzhou

Approved By:



Strong Yao

Manager

Intertek Guangzhou

This report is for the exclusive use of Intertek's Client and is provided pursuant to the agreement between Intertek and its Client. Intertek's responsibility and liability are limited to the terms and conditions of the agreement. Intertek assumes no liability to any party, other than to the Client in accordance with the agreement, for any loss, expense or damage occasioned by the use of this report. Only the Client is authorized to permit copying or distribution of this report and then only in its entirety. Any use of the Intertek name or one of its marks for the sale or advertisement of the tested material, product or service must first be approved in writing by Intertek. The observations and test results in this report are relevant only to the sample tested. This report by itself does not imply that the material, product, or service is or has ever been under an Intertek certification program.

TEST REPORT

CONTENT

CONTENT	3
1. TEST RESULTS SUMMARY	4
2. EMC RESULTS CONCLUSION	5
3. LABORATORY MEASUREMENTS	7
4. EQUIPMENT USED DURING TEST	8
5. EMI TEST	11
5.1 EN 61000-6-3 CONTINUOUS CONDUCTED DISTURBANCE VOLTAGE TEST	11
5.1.1 <i>Block Diagram of Test Setup</i>	11
5.1.2 <i>Test Setup and Procedure</i>	11
5.1.3 <i>Test Data and curve</i>	12
5.2 EN 61000-6-3 DISCONTINUOUS CONDUCTED DISTURBANCE VOLTAGE	16
5.3 EN 61000-6-3 EMISSION AT TELECOMMUNICATIONS/NETWORK PORTS.....	16
5.4 EN 61000-6-3 RADIATED EMISSION BELOW 1 GHZ.....	17
5.4.1 <i>Block Diagram of Test Setup</i>	17
5.4.2 <i>Test Setup and Procedure</i>	17
5.4.3 <i>Test Data and Curve</i>	18
5.5 EN 61000-6-3 RADIATED EMISSION ABOVE 1 GHZ	20
6. HARMONICS OF CURRENT	21
6.1 BLOCK DIAGRAM OF TEST SETUP	21
6.2 TEST SETUP AND PROCEDURE.....	21
6.3 TEST DATA.....	21
7. FLICKER	34
7.1 BLOCK DIAGRAM OF TEST SETUP	34
7.2 TEST SETUP AND PROCEDURE.....	34
7.3 TEST DATA.....	35
8. EMS TEST	40
8.1 EN 61000-4-2(PURSUANT TO EN 61000-6-1) ELECTROSTATIC DISCHARGE IMMUNITY	40
8.2 EN 61000-4-6(PURSUANT TO EN 61000-6-1) INJECTED CURRENT (0.15 MHZ TO 80 MHZ) 43	
8.3 EN 61000-4-4(PURSUANT TO EN 61000-6-1) ELECTRICAL FAST TRANSIENT/BURST.....	44
8.4 EN 61000-4-5(PURSUANT TO EN 61000-6-1) SURGE IMMUNITY	45
8.5 EN 61000-4-11(PURSUANT TO EN 61000-6-1) VOLTAGE DIPS AND INTERRUPTIONS	46
8.6 EN 61000-4-3(PURSUANT TO EN 61000-6-1) RADIATED ELECTROMAGNETIC FIELD IMMUNITY	47
8.7 EN 61000-4-8(PURSUANT TO EN 61000-6-1) POWER FREQUENCY MAGNETIC FIELD	
IMMUNITY.....	50
9. APPENDIX II – PHOTOS OF EUT	52

TEST REPORT

1. TEST RESULTS SUMMARY

Test Item	Standard	Result
Continuous conducted disturbance voltage	EN 61000-6-3:2007+A1:2011 Reference: EN 55016-2-1:2009	Pass
Discontinuous conducted disturbance voltage	EN 61000-6-3:2007+A1:2011 Reference: EN 55014-1:2006+A1:2009	N/A
Emission at Telecommunications / network Ports	EN 61000-6-3:2007+A1:2011 Reference: EN 55022:2010	N/A
Radiated emission (30 MHz–1000 MHz)	EN 61000-6-3:2007+A1:2011 Reference: EN 55016-2-3:2010	Pass
Radiated emission (1 GHz–6 GHz)	EN 61000-6-3:2007+A1:2011 Reference: EN 55016-2-3:2010	N/A
Harmonic of current	EN 61000-6-3:2007+A1:2011 Reference: EN 61000-3-2 :2014 Reference: EN 61000-3-12 :2011	Pass
Flicker	EN 61000-6-3:2007+A1:2011 Reference: EN 61000-3-3:2013 Reference: EN 61000-3-11:2000	Pass
ESD immunity	EN 61000-6-1:2007 Reference: EN 61000-4-2:2009	Pass
Radiated EM field immunity	EN 61000-6-1:2007 Reference: EN 61000-4-3:2006 +A1:2008 + A2:2010	Pass
EFT immunity	EN 61000-6-1:2007 Reference: EN 61000-4-4:2012	Pass
Surge immunity	EN 61000-6-1:2007 Reference: EN 61000-4-5:2006	Pass
Inject current immunity	EN 61000-6-1:2007 Reference: EN 61000-4-6:2009	Pass
Power frequency magnetic field immunity	EN 61000-6-1:2007 Reference: EN 61000-4-8:2010	Pass
Voltage dips and interruption immunity	EN 61000-6-1:2007 Reference: EN 61000-4-11:2004	N/A

Remark:

1. The symbol "N/A" in above table means Not Applicable.
2. When determining the test results, measurement uncertainty of tests has been considered.

TEST REPORT

2. EMC RESULTS CONCLUSION

RE: EMC Testing Pursuant to EMC Directive 2014/30/EU performed on the Solar Grid Tied Inverter, Models: EVVO 3000TL3P, EVVO 4000TL3P, EVVO 4800TL3P, EVVO 5000TL3P, EVVO 6000TL3P, EVVO 8000TL3P, EVVO 10000TL3P, EVVO 12000TL3P

Model differences:

All models have identical mechanical and electrical construction except some parameter of the software architecture in order to control the max output power. The detailed difference as following:

Model	EVVO 8000TL3P, EVVO 10000TL3P, EVVO 12000TL3P		EVVO 3000TL3P, EVVO 4000TL3P, EVVO 4800TL3P, EVVO 5000TL3P, EVVO 6000TL3P	
Componets	Specification	Numbers	Specification	Numbers
Inverter Chock	NPS226060*2+NPF226060*1 2.0Φ*2P*42Ts L=0.73mH	3	NPS226060*2 2.2Φ*1P*67Ts L=1.24mH	3
Bus capacitor	75μF/600V	4	75μF/600V	2

We tested the PV Grid inverter, representative model: EVVO 12000TL3P with all EMI and EMS test, and additional Harmonic of current and Flicker test item on model EVVO 3000TL3P, to determine if they were in compliance with the relevant EN standards as marked on the Test Results Summary. We found that the unit met the requirement of EN 61000-6-3, EN 61000-6-1 (EN 61000-4-2), EN 61000-6-1 (EN 61000-4-3), EN 61000-6-1 (EN 61000-4-4), EN 61000-6-1 (EN 61000-4-5), EN 61000-6-1 (EN 61000-4-6), EN 61000-6-1(EN 61000-4-8) standards when tested as received. The worst case's test data was presented in this test report.

The production units are required to conform to the initial sample as received when the units are placed on the market.

TEST REPORT

Electrical Rating:

MODEL	EVVO 3000TL3P	EVVO 4000TL3P	EVVO 4800TL3P	EVVO 5000TL3P	EVVO 6000TL3P
Max PV voltage	1000Vdc				
MPPT Voltage range	160-960Vdc				
Max. input current	11/11A				
PV Isc	14/14A				
Rated Power (W)	3000	4000	5000	5000	6000
Max power (VA)	3300	4400	5000	5500	6600
Max output current	3×4.8 A	3×6.4 A	3×8.0A	3×8.0 A	3×9.6 A
Output voltage	3W/N/PE 230Vac/400Vac				
Nominal Frequency	50 Hz				
Power Factor	1 default (+/- 0.8 adjustable)				
Ambient Temperature	-25°C - +60°C				
Protection Degree	IP65				
Protection Class	Class I				
MODEL	EVVO 8000TL3P	EVVO 10000TL3P	EVVO 12000TL3P		
Max PV voltage	1000Vdc				
MPPT Voltage range	160-960Vdc				
Max. input current	11/11A				
PV Isc	14/14A				
Rated power (W)	8000	10000	12000		
Max power (VA)	8800	11000	13200		
Max output current	3×12.8 A	3×15.9 A	3×19.1 A		
Output voltage	3W/N/PE 230Vac/400Vac				
Nominal Frequency	50 Hz				
Power Factor	1 default (+/- 0.8 adjustable)				
Ambient Temperature	-25°C - +60°C				
Protection Degree	IP65				
Protection Class	Class I				
Software Version	V 1.10				

TEST REPORT

3. LABORATORY MEASUREMENTS

Configuration Information

Support Equipment: N/A

Rated Voltage and frequency under test: See page 6

Condition of Environment: Temperature: 22~28°C
Relative Humidity:35~60%
Atmosphere Pressure:86~106kPa

Notes:

1. The EMI measurements had been made in the operating mode produced the largest emission in the frequency band being investigated consistent with normal applications. An attempt had been made to maximize the emission by varying the configuration of the EUT.
2. The EMS measurements had been made in the frequency bands being investigated, with the EUT in the most susceptible operating mode consistent with normal applications. The configuration of the test sample had been varied to achieve maximum susceptibility.
3. Test Location:
All tests were performed at:
Shenzhen EMTEK Co.,Ltd.
Bldg. 69, Majialong Industry Zone, Nanshan District, Shenzhen,Guangdong,China.

4.Measurement Uncertainty

No.	Item	Measurement Uncertainty
1	Conduction Emission (9 kHz-150 kHz)	2.96 dB
2	Conduction Emission (150 kHz-30 MHz)	2.74dB
3	Disturbance Power (30 MHz-300 MHz)	2.53dB
4	Radiated Emission (30 MHz-1 GHz)	H: 3.96dB; V: 4.04dB
5	Radiated Emission (1 GHz-6 GHz)	4.46dB
6	Radiated Emission (6 GHz-18 GHz)	4.96dB

The measurement uncertainty describes the overall uncertainty of the given measured value during the operation of the EUT.

Measurement uncertainty is calculated in accordance with CISPR16-4-2:2011

The measurement uncertainty is given with a confidence of 95%, k=2.

TEST REPORT

4. EQUIPMENT USED DURING TEST

Conducted emission (AC power port)						
Equ.No.	Equipment	Manufacturer	Model No.	Serial No.	Last Cal.	Cal. Interval
EE-144	EMI Test Receiver	Rohde & Schwarz	ESCI	101045	2019/5/19	1Year
EE-023-2	PULSE LIMITER	Rohde & Schwarz	ESH3-Z2	100107	2019/5/18	1Year
EE-032	AMN	Rohde & Schwarz	ESH3-Z5	100191	2019/5/18	1Year
EE-156	AMN	Schwarzbeck	NNLK 8129	8129203	2019/5/18	1Year
EE-033	V-Network	Rohde & Schwarz	ESH3-Z6	100011	2019/5/18	1Year
EE-138	V-Network	Rohde & Schwarz	ESH3-Z6	100253	2019/5/18	1Year

Radiated emission						
Equ.No.	Equipment	Manufacturer	Model No.	Serial No.	Last Cal.	Cal. Interval
EE-157	Loop Antenna	Schwarzbeck	FMZB1519	1519-012	2019/7/14	2 Year
EE-246	Bilog Antenna	Schwarzbeck	VULB9163	661	2019/9/22	2 Year
EE-371	Bilog Antenna	Schwarzbeck	VULB9163	712	2019/9/22	2 Year
EE-249	EMI Test Receiver	Rohde & Schwarz	ESR3	101707	2019/5/19	1 Year
EE-226	EMI Test Receiver	Rohde & Schwarz	ESR3	101706	2019/5/19	1 Year
EE-235	Pre-Amplifier	Lunar EM	LNA10M1G-40	J1011131126001	2019/5/19	1 Year
EE-263	Pre-Amplifier	Lunar EM	LNA10M1G-40	J1011131126002	2019/5/19	1 Year

Harmonic current, Flicker						
Equ.No.	Equipment	Manufacturer	Model No.	Serial No.	Last Cal.	Cal. Interval
EE-206	45KVA AC Power source	Teseq	NSG 1007-45/45KVA	1305A02873	2019/5/19	1 Year
EE-206-1	Signal conditioning Unit	Teseq	CCN 1000-3	1305A02873	2019/5/19	1 Year
EE-206-2	Impedance network	Teseq	INA2197/37A	1305A02873	2019/5/19	1 Year
EE-206-3	Impedance network	Teseq	INA 2196/75A	1305A02874	2019/5/19	1 Year
EE-207	Proflin 2100 AC Switching Unit	Teseq	NSG 2200-3	A22714	2019/5/19	1 Year

ESD						
Equ.No.	Equipment	Manufacturer	Model No.	Serial No.	Last Cal.	Cal. Interval
EE-195	ESD Tester	TESEQ	NSG 438A	130	2019/7/28	1 Year

TEST REPORT

EFT/B						
Equ.No.	Equipment	Manufacturer	Model No.	Serial No.	Last Cal.	Cal. Interval
EE-014	Burst Tester	HAEFELY	PEFT4010	080981-16	2019/5/18	1Year
EE-015	Coupling Clamp	HAEFELY	IP-4A	147147	2019/5/18	1Year
EE-205	Three phase CDN	Teseq	CDN 163	202	2019/5/18	1 Year

Surge						
Equ.No.	Equipment	Manufacturer	Model No.	Serial No.	Last Cal.	Cal. Interval
EE-162	Controller	HAEFELY	Psurge 8000	174031	2019/5/18	1Year
EE-162-1	Impulse Module	HAEFELY	PIM 100	174124	2019/5/18	1Year
EE-162-2	Coupling Decoupling	HAEFELY	PCD 130	172181	2019/5/18	1Year
EE-162-3	Coupling Module	HAEFELY	PCD122	174354	2019/5/18	1Year
EE-162-4	Impulse Module	HAEFELY	PIM 120	174435	2019/5/18	1Year
EE-162-5	Coupling Module	HAEFELY	PCD 126A	174387	2019/5/18	1Year
EE-162-6	Impulse Module	HAEFELY	PIM 110	174391	2019/5/18	1Year
EE-227	Impulse Module	HAEFELY	PIM 150	178707	2019/5/18	1Year
EE-623	Impulse Module	PMI	PCDN8	190422	2019/5/18	1Year

R/S						
Equ.No.	Equipment	Manufacturer	Model No.	Serial No.	Last Cal.	Cal. Interval
EE-066-2	Power Amplifier	MILMEGA	AS0102-55	1018770	2019/5/19	1 Year
EE-066-4	50ohm Diode Power Sensor	BOONTON	51011EMC	34236	2019/5/19	1 Year
EE-066-6	RF Power Meter. Dual Channel	BOONTON	4232A	10539	2019/5/19	1 Year
EE-067	Log.-Per. Antenna	SCHWARZBECK	VULP 9118E	811	N/A	N/A
EE-218	Signal Generator	Agilent	N5181A	MY50145187	2019/5/19	1 Year
EE-219	50ohm Diode Power Sensor	BOONTON	51011EMC	36164	2019/5/19	1 Year
EE-220	Broad-Band Horn Antenna	SCHWARZBECK	STLP 9149	9149-227	N/A	N/A
EE-221	Field Strength Meter	DARE	RSS1006A	10I00037SNO22	2019/5/19	1 Year
EE-222	Multi-function interface system	DARE	CTR1009B	12I00250SNO72	N/A	N/A
EE-223	Automatic switch group	DARE	RSW1004A	N/A	N/A	N/A
EE-224	Power Amplifier	MILMEGA	AS1860-50	1059346	2019/5/19	1 Year
EE-225	Power Amplifier	MILMEGA	80RF1000-175	1059345	2019/5/19	1 Year
EE-225-1	Directional Coupler	MILMEGA	DC6180AM1	0340463	2019/5/18	1 Year
EE-115	Audio Analyzer	R&S	UPV	101473	2019/5/19	1 Year
EE-615	Audio Test System	AUDIO PRECISION	ATS-1	41100	2019/8/31	1 Year

TEST REPORT

Immunity to conducted disturbances, induced by radio-frequency fields						
Equ.No.	Equipment	Manufacturer	Model No.	Serial No.	Last Cal.	Cal. Interval
EE-007-1	Continuous Wave Simulator	EMTEST	CWS500C	0900-12	2019/5/19	1Year
EE-007-2	CDN	EMTEST	CDN-M2	510010010010	2019/5/18	1Year
EE-007-3	CDN	EMTEST	CDN-M3	0900-11	2019/5/18	1Year
EE-007-4	EM Injection Clamp	EMTEST	F-2031-23MM	368	2019/5/18	1Year
EE-007-5	Attenuator	EMTEST	100W 6dB DC-3G	/	2019/5/18	1Year
EE-111	Signal Generator	R&S	SMB100A	103041	2019/5/19	1Year
EE-146	CDN	LUTHI	CDN L-801 M2/M3	2606	2019/5/18	1Year
EE-204	Three phase CDN	TESEQ	CDN M332S	32655	2019/5/18	1 Year
EE-204-1	Three phase CDN	TESEQ	CDN M432S	33670	2019/5/18	1 Year
EE-204-2	Three phase CDN	TESEQ	CDN M432-3LNS	34048	2019/5/18	1 Year
EE-204-3	Three phase CDN	TESEQ	CDN M532S	33799	2019/5/18	1 Year
EE-345	Current Injection Clamp	FCC	F-120-9	140302	2019/5/18	1 Year
EE-616	Power meter	AGILENT	E4418B	MY45102886	2019/5/19	1 Year
EE-616-1	Directional coupler	SKET	DC_0110000M- 100W	SK2018080301	2019/5/19	1 Year
EE-115	Audio Analyzer	R&S	UPV	101473	2019/5/19	1 Year
EE-615	Audio Test System	AUDIO PRECISION	ATS-1	41100	2019/8/31	1 Year

Power frequency magnetic field						
Equ.No.	Equipment	Manufacturer	Model No.	Serial No.	Last Cal.	Cal. Interval
EE-006	Magnetic Field Tester	HAEFELY	MAG100	250040.1	2019/5/28	1Year

TEST REPORT

5. EMI TEST

5.1 EN 61000-6-3 Continuous Conducted Disturbance Voltage Test

Test Result: Pass

5.1.1 Block Diagram of Test Setup

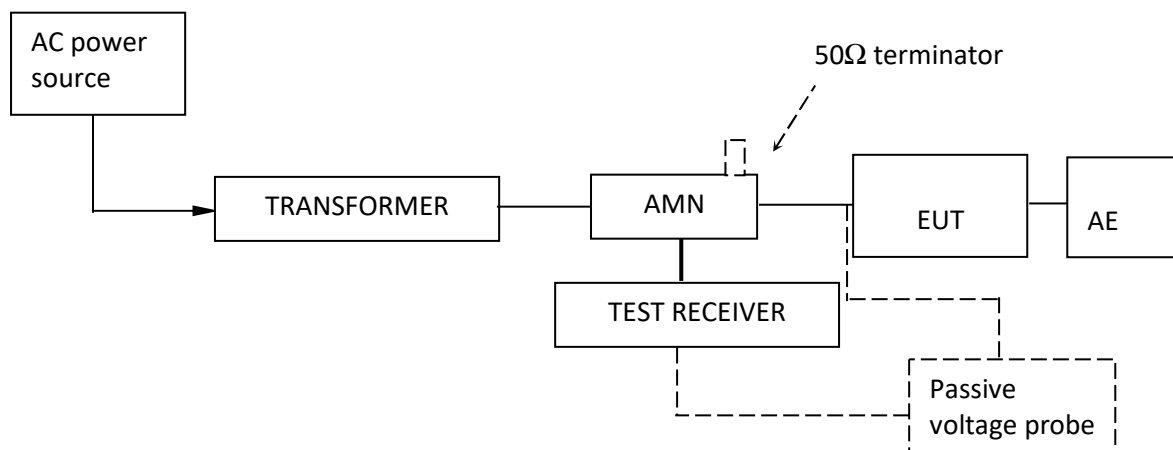

5.1.2 Test Setup and Procedure

The EUT was set to achieve the maximum emission level. The mains terminal disturbance voltage was measured with the EUT in a shielded room. The EUT was connected to AC power source through an Artificial Mains Network which provides a 50Ω linear impedance artificial hand is used if appropriate (for handheld apparatus). The load/control terminal disturbance voltage was measured with passive voltage probe if appropriate.

The table-top EUT was placed on a 0.8m high non-metallic table above earthed ground plane (Ground Reference Plane). And for floor standing EUT, was placed on a 0.1m high non-metallic supported on GRP. The EUT keeps a distance of at least 0.4m from a vertical metallic surface. The Artificial Mains Network is situated at a distance of 0.8m from the EUT.

During the test, mains lead of EUT excess 0.8m was folded back and forth parallel to the lead so as to form a horizontal bundle with a length between 0.3m and 0.4m.

The bandwidth of test receiver was set at 9 kHz. The frequency range from 150 kHz to 30 MHz was checked.

TEST REPORT

5.1.3 Test Data and curve

At mains terminal:

Tested Wire: Live 1

Operation Mode: Inverting mode with full load

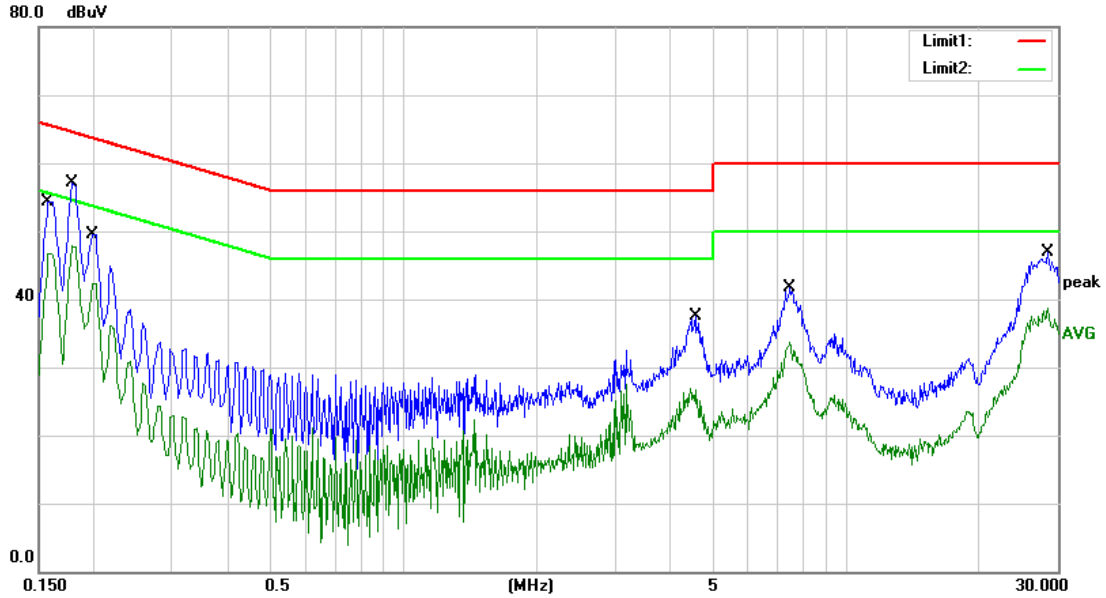

No.	Mk.	Freq. MHz	Reading Level dBuV	Correct Factor dB	Measure- ment dBuV	Limit dBuV	Over dB	Detector
1		0.1580	44.47	9.89	54.36	65.57	-11.21	QP
2		0.1580	36.87	9.89	46.76	55.57	-8.81	AVG
3		0.1780	47.17	9.89	57.06	64.58	-7.52	QP
4	*	0.1780	37.94	9.89	47.83	54.58	-6.75	AVG
5		0.1986	39.57	9.89	49.46	63.67	-14.21	QP
6		0.1986	32.49	9.89	42.38	53.67	-11.29	AVG
7		4.5620	27.52	10.00	37.52	56.00	-18.48	QP
8		4.5620	16.92	10.00	26.92	46.00	-19.08	AVG
9		7.4740	31.56	10.04	41.60	60.00	-18.40	QP
10		7.4740	23.65	10.04	33.69	50.00	-16.31	AVG
11		28.5420	36.58	10.29	46.87	60.00	-13.13	QP
12		28.5420	28.37	10.29	38.66	50.00	-11.34	AVG

TEST REPORT

Tested Wire: Live 2

Operation Mode: Inverting mode with full load

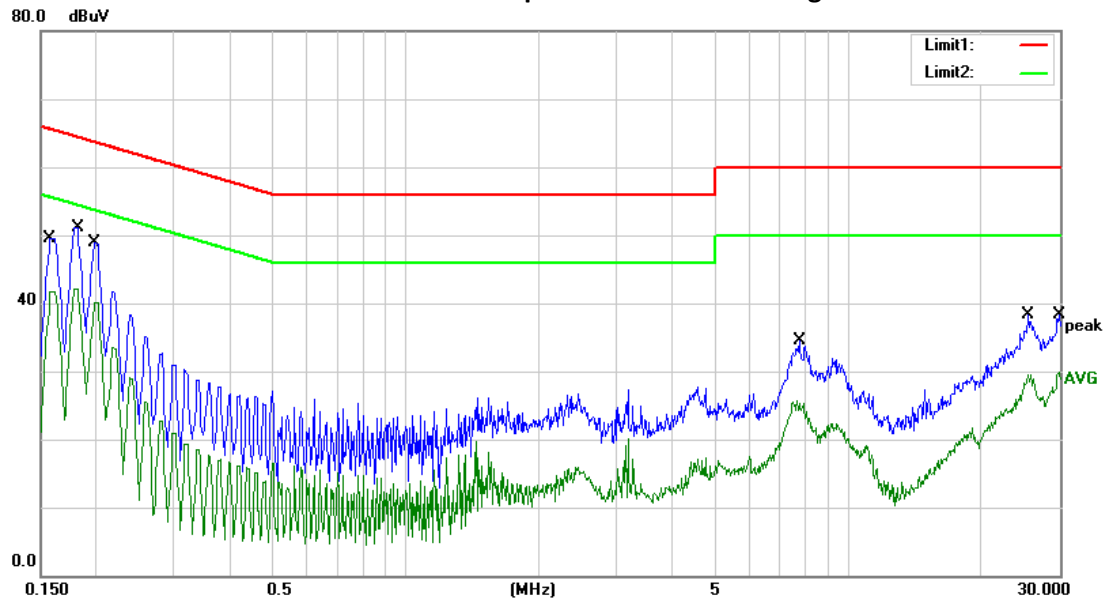

No.	Mk.	Freq. MHz	Reading Level dBuV	Correct Factor dB	Measure- ment dBuV	Limit dBuV	Over dB	Detector
1		0.1580	39.67	9.89	49.56	65.57	-16.01	QP
2		0.1580	31.86	9.89	41.75	55.57	-13.82	AVG
3		0.1820	41.16	9.89	51.05	64.39	-13.34	QP
4	*	0.1820	32.23	9.89	42.12	54.39	-12.27	AVG
5		0.1980	39.03	9.89	48.92	63.69	-14.77	QP
6		0.1980	30.27	9.89	40.16	53.69	-13.53	AVG
7		7.7500	24.40	10.04	34.44	60.00	-25.56	QP
8		7.7500	15.64	10.04	25.68	50.00	-24.32	AVG
9		25.4820	28.07	10.25	38.32	60.00	-21.68	QP
10		25.4820	19.34	10.25	29.59	50.00	-20.41	AVG
11		29.9620	27.94	10.31	38.25	60.00	-21.75	QP
12		29.9620	19.63	10.31	29.94	50.00	-20.06	AVG

TEST REPORT

Tested Wire: Live 3

Operation Mode: Inverting mode with full load

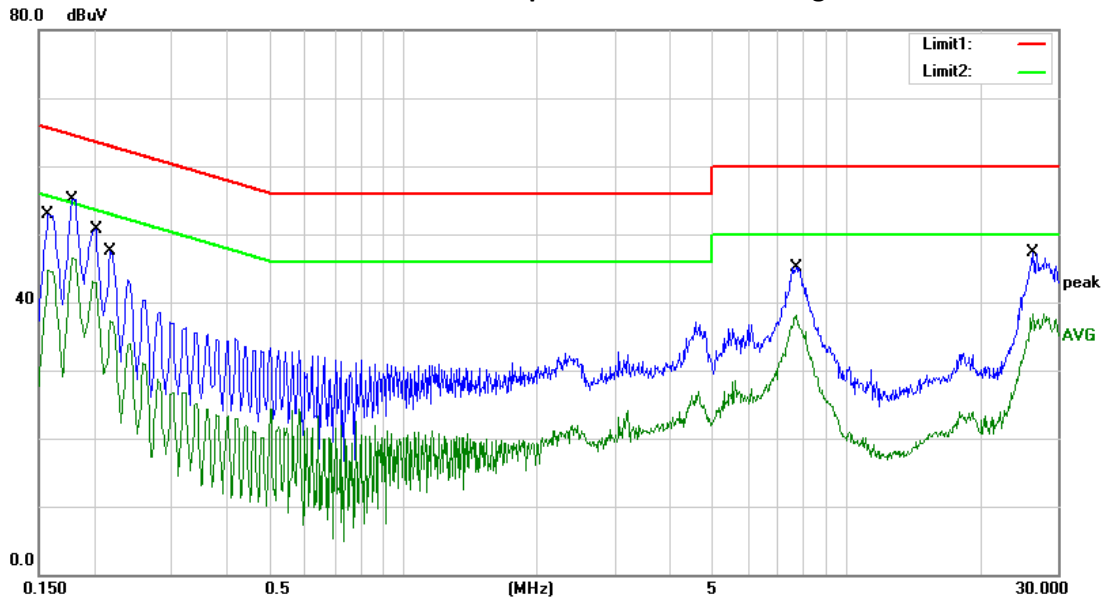

No.	Mk.	Freq.	Reading Level	Correct Factor	Measurement	Limit	Over	Detector
		MHz	dBuV	dB	dBuV	dBuV	dB	
1		0.1580	42.97	9.89	52.86	65.57	-12.71	QP
2		0.1580	34.75	9.89	44.64	55.57	-10.93	AVG
3		0.1780	45.24	9.89	55.13	64.58	-9.45	QP
4	*	0.1780	36.64	9.89	46.53	54.58	-8.05	AVG
5		0.2020	40.87	9.90	50.77	63.53	-12.76	QP
6		0.2020	33.11	9.90	43.01	53.53	-10.52	AVG
7		0.2180	37.55	9.90	47.45	62.89	-15.44	QP
8		0.2180	27.38	9.90	37.28	52.89	-15.61	AVG
9		7.6940	35.08	10.04	45.12	60.00	-14.88	QP
10		7.6940	28.00	10.04	38.04	50.00	-11.96	AVG
11		26.2820	37.13	10.26	47.39	60.00	-12.61	QP
12		26.2820	28.14	10.26	38.40	50.00	-11.60	AVG

Remark:

1. Corr. (dB) = LISN Factor (dB) + Cable Loss (dB)
2. Level (dBμV) = Corr. (dB) + Read Level (dBμV)
3. Delta Limit (dB) = Level (dBμV)-Limit (dBμV)

TEST REPORT

Tested Wire: Neutral

Operation Mode: Inverting mode with full load

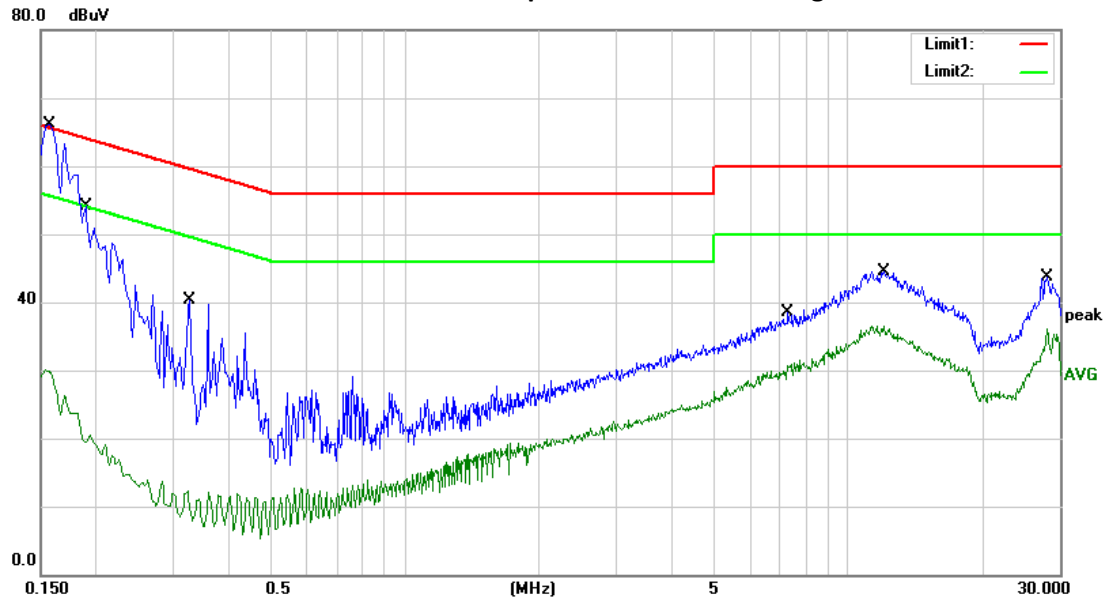

No.	Mk.	Freq.	Reading Level	Correct Factor	Measurement	Limit	Over	Detector
		MHz	dBµV	dB	dBµV	dBµV	dB	
1	*	0.1580	47.91	9.89	57.80	65.57	-7.77	QP
2		0.1580	20.18	9.89	30.07	55.57	-25.50	AVG
3		0.1903	42.70	9.89	52.59	64.02	-11.43	QP
4		0.1903	9.31	9.89	19.20	54.02	-34.82	AVG
5		0.3260	30.35	9.90	40.25	59.55	-19.30	QP
6		0.3260	3.82	9.90	13.72	49.55	-35.83	AVG
7		7.2940	28.40	10.03	38.43	60.00	-21.57	QP
8		7.2940	21.63	10.03	31.66	50.00	-18.34	AVG
9		12.0020	34.46	10.09	44.55	60.00	-15.45	QP
10		12.0020	26.45	10.09	36.54	50.00	-13.46	AVG
11		28.0820	33.45	10.28	43.73	60.00	-16.27	QP
12		28.0820	25.85	10.28	36.13	50.00	-13.87	AVG

Remark:

1. Corr. (dB) = LISN Factor (dB) + Cable Loss (dB)
2. Level (dBµV) = Corr. (dB) + Read Level (dBµV)
3. Delta Limit (dB) = Level (dBµV)-Limit (dBµV)

TEST REPORT

5.2 EN 61000-6-3 Discontinuous Conducted Disturbance Voltage

Test Result: Not applicable

5.3 EN 61000-6-3 Emission at Telecommunications/network Ports

Test Result: Not Applicable

Remark: The test only apply to balanced telecommunication ports intended for connection to unscreened balanced pairs

TEST REPORT

5.4 EN 61000-6-3 Radiated Emission below 1 GHz

Test Result: Pass

5.4.1 Block Diagram of Test Setup

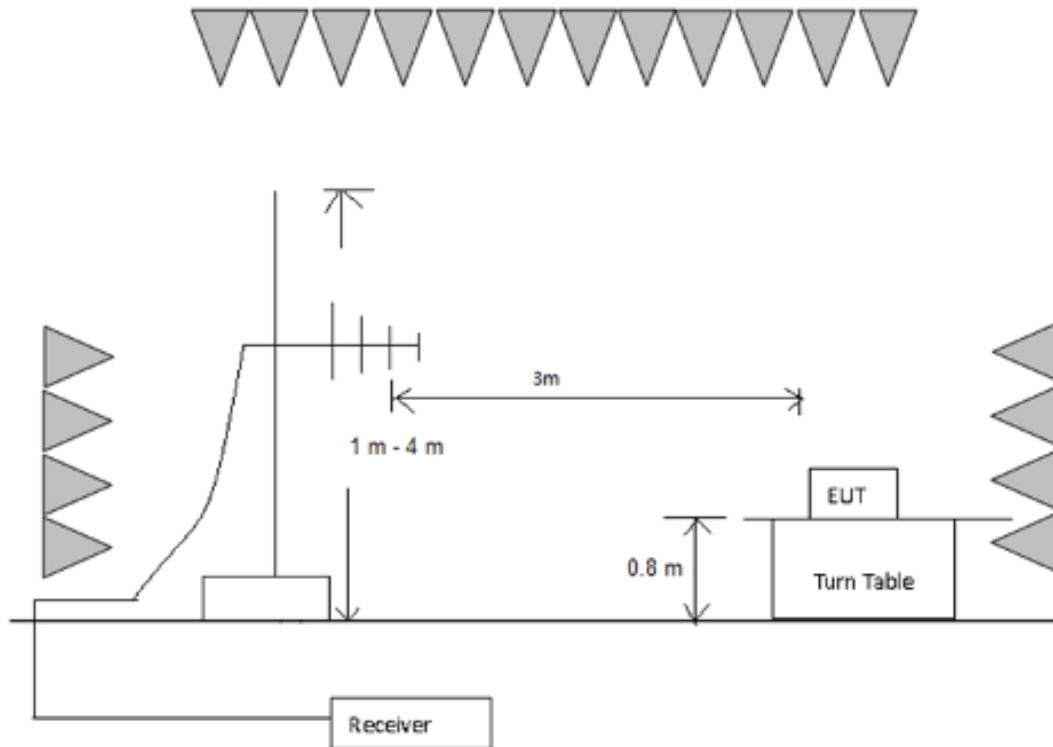

5.4.2 Test Setup and Procedure

The measurement was applied in a semi-anechoic chamber. The EUT and simulators were placed on a 0.8m high wooden turntable above the horizontal metal ground plane. The turn table rotated 360 degrees to determine the position of the maximum emission level. The EUT was set 10 meters away from the receiving antenna which was mounted on an antenna mask. The antenna moved up and down between from 1meter to 4 meters to find out the maximum emission level.

Broadband antenna was used as receiving antenna. Both horizontal and vertical polarization of the antenna was set on measurement. In order to find the maximum emission, all of the interface cables were manipulated according to EN55032 requirement during radiated test. The bandwidth setting on R&S Test Receiver was 120 kHz. The frequency range from 30MHz to 1000MHz was checked

TEST REPORT

5.4.3 Test Data and Curve

Operation Mode: Inverting mode with full load

Horizontal

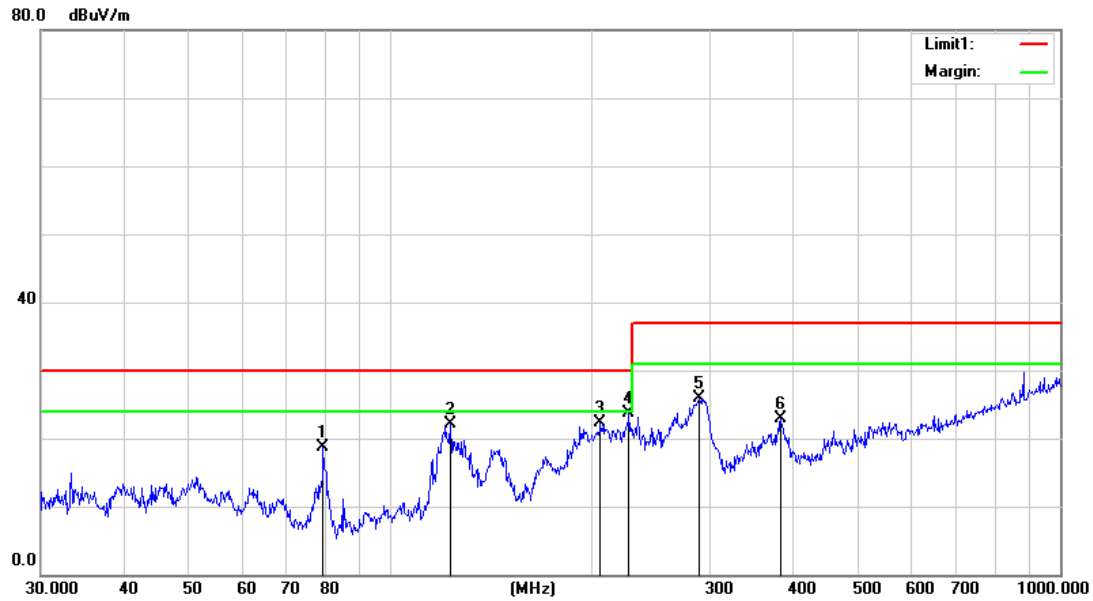

No.	Mk.	Freq. MHz	Reading Level dBuV	Ant. Factor dB/m	Pre Amp Gain dB	Cable loss dB	Measure- ment dBuV/m	Limit dBuV/m	Over dB	Detector
1		79.2426	53.01	7.56	43.51	1.55	18.61	30.00	-11.39	QP
2		122.8340	54.37	9.18	43.53	2.1	22.12	30.00	-7.88	QP
3		205.6751	52.09	10.97	43.28	2.45	22.23	30.00	-7.77	QP
4	*	226.8936	52.57	11.68	43.19	2.66	23.72	30.00	-6.28	QP
5		289.0021	51.51	13.4	42.94	3.86	25.83	37.00	-11.17	QP
6		382.5880	44.24	15.55	42.49	5.52	22.82	37.00	-14.18	QP

Remark:

1. Corr. (dB) = Antenna Factor (dB) + Cable Loss (dB)
2. Quasi Peak (dBμV/m) = Corr. (dB) + Read Level (dBμV)
3. Margin (dB) = Limit QPK (dBμV/m) – Quasi Peak (dBμV/m)

TEST REPORT

Vertical

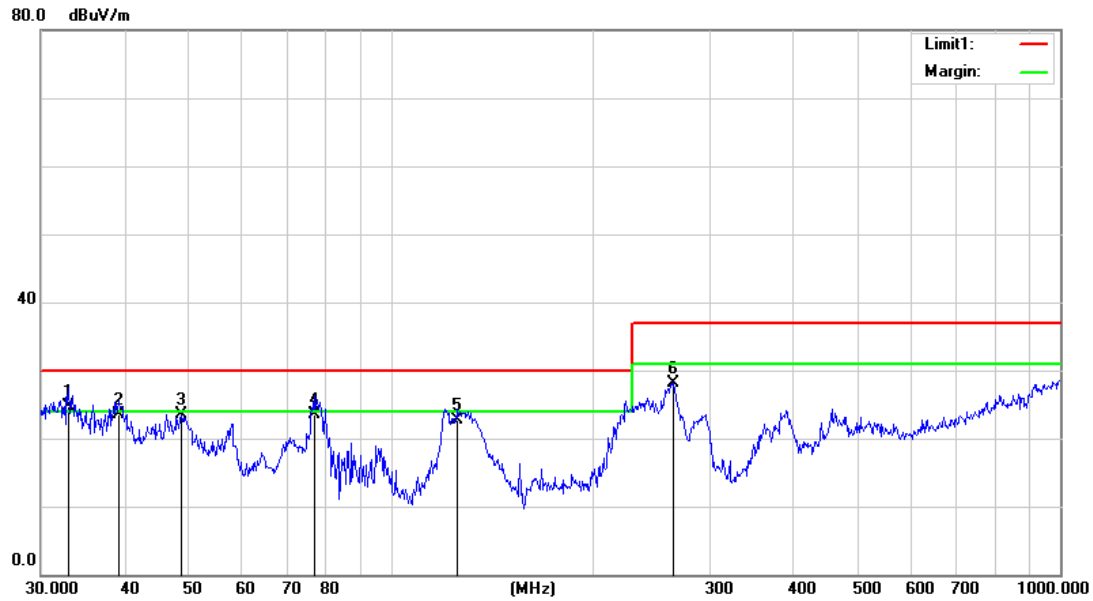

No.	Mk.	Freq. MHz	Reading Level dBuV	Ant. Factor dB/m	Pre Amp Gain dB	Cable loss dB	Measure- ment dBuV/m	Limit dBuV/m	Over dB	Detector
1	*	32.9791	56.25	10.85	43.3	1	24.80	30.00	-5.20	QP
2		39.1616	53.28	12.63	43.33	1.02	23.60	30.00	-6.40	QP
3		48.6720	51.90	13.87	43.37	1.06	23.46	30.00	-6.54	QP
4		76.7808	57.74	7.76	43.5	1.5	23.50	30.00	-6.50	QP
5		125.4457	55.44	8.65	43.52	2.13	22.70	30.00	-7.30	QP
6		264.7457	54.82	12.99	43.04	3.25	28.02	37.00	-8.98	QP

Remark:

1. Corr. (dB) = Antenna Factor (dB) + Cable Loss (dB)
2. Quasi Peak (dBμV/m) = Corr. (dB) + Read Level (dBμV)
3. Margin (dB) = Limit QPK (dBμV/m) – Quasi Peak (dBμV/m)

TEST REPORT

5.5 EN 61000-6-3 Radiated Emission above 1 GHz

Test Result: Not Applicable

Remark:

The highest internal source of the EUT is not more than 108 MHz, so the measurement above 1000 MHz is not applicable.

TEST REPORT

6. Harmonics of current

Test Result: Pass

6.1 Block Diagram of Test Setup

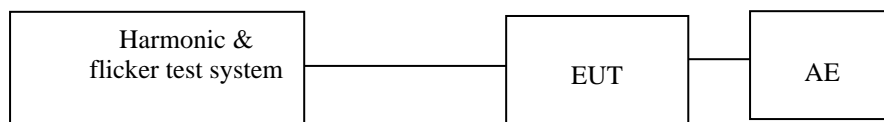

6.2 Test Setup and Procedure

Harmonics of the fundamental current were measured up to 40 order harmonics using a digital power meter with an analogue output and frequency analyzer which was integrated in the harmonic & flicker test system. The measurements were carried out under steady conditions.

6.3 Test Data

TEST REPORT

Model: EVVO 12000TL3P

Mode: Inverting mode with full load

Harmonics – Per EN/IEC61000-3-12, Ed. 2.0(Phase A-Run time)

Test Result: Pass Source qualification: Normal

Current & voltage waveforms

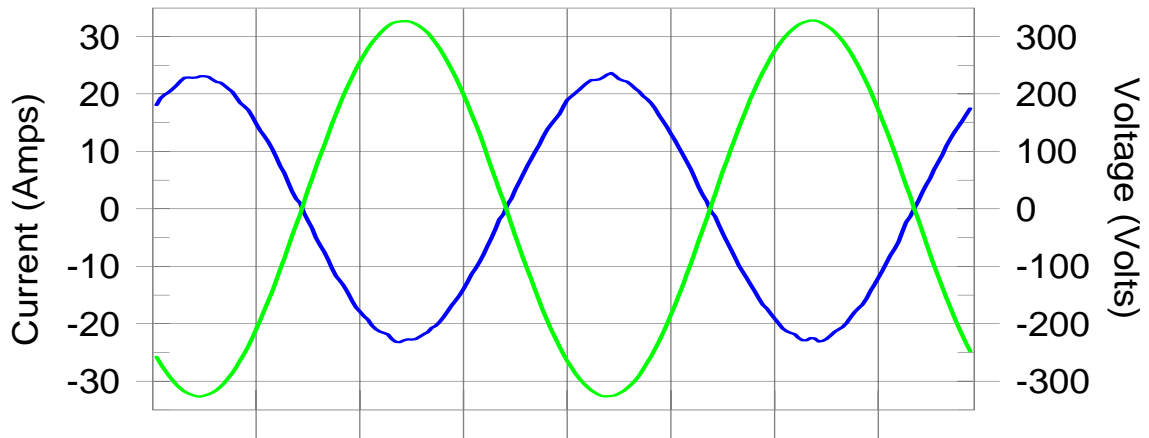

Harmonics and Class 3 limit line

European Limits

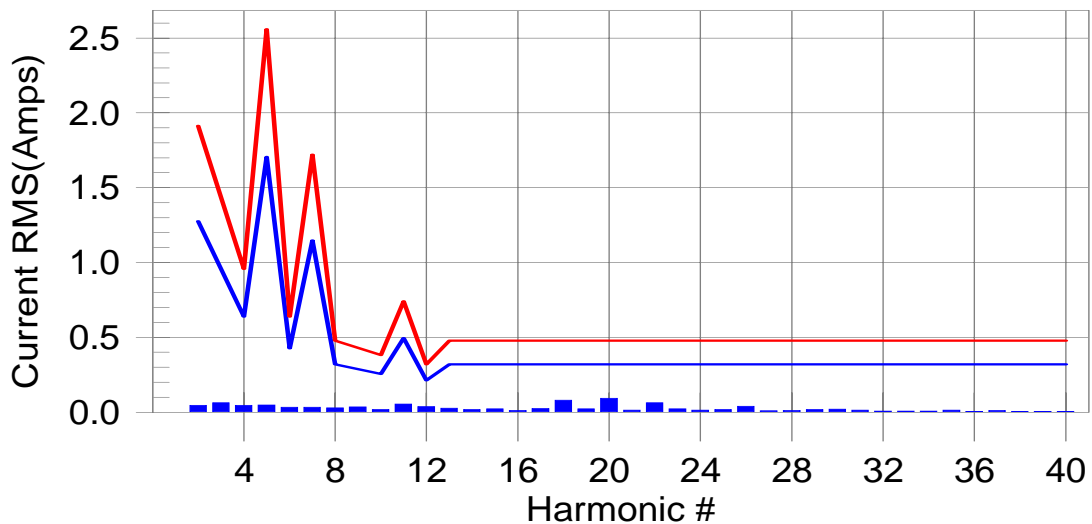

Test result: Pass Worst harmonics H12-13.6% of 150% limit, H12-17.2% of 100% limit.

TEST REPORT

Current Test Result Summary (Phase A-Run time)

Test Result: Pass Measured Iref: 15.940(Amps) Source: Normal
THC/Iref (%): 0.0 Limit (%): 13.0 PWHC/Iref (%): 0.0 PWHC Limit (%): 22.0

Highest parameter values during test:

V_RMS (Volts):	231.43	Frequency (Hz):	50.00
I_Peak (Amps):	23.997	I_RMS (Amps):	16.247
I_Fund (Amps):	15.938(avg)	Crest Factor:	1.507
Power (Watts):	-3782	Power Factor:	-1.000

Harm#	Harms(avg)	100%Limit	%of Limit	Harms(max)	150%Limit	%of Limit	Status
2	0.046	1.275	3.6	0.050	1.913	2.6	Pass
3	0.062	N/A	N/A	0.068	N/A	N/A	N/A
4	0.046	0.638	7.2	0.049	0.956	5.1	Pass
5	0.049	1.706	2.9	0.054	2.558	2.1	Pass
6	0.033	0.425	7.7	0.036	0.638	5.6	Pass
7	0.031	1.148	2.7	0.033	1.722	1.9	Pass
8	0.029	0.319	9.3	0.033	0.478	7.0	Pass
9	0.036	N/A	N/A	0.041	N/A	N/A	N/A
10	0.019	0.255	7.5	0.022	0.383	5.7	Pass
11	0.055	0.494	11.2	0.062	0.741	8.3	Pass
12	0.037	0.213	17.2	0.043	0.319	13.6	Pass
13	0.027	0.319	8.6	0.030	0.478	6.4	Pass
14	0.018	N/A	N/A	0.021	N/A	N/A	N/A
15	0.022	N/A	N/A	0.027	N/A	N/A	N/A
16	0.011	N/A	N/A	0.016	N/A	N/A	N/A
17	0.025	N/A	N/A	0.031	N/A	N/A	N/A
18	0.079	N/A	N/A	0.083	N/A	N/A	N/A
19	0.023	N/A	N/A	0.030	N/A	N/A	N/A
20	0.092	N/A	N/A	0.099	N/A	N/A	N/A
21	0.013	N/A	N/A	0.015	N/A	N/A	N/A
22	0.063	N/A	N/A	0.075	N/A	N/A	N/A
23	0.021	N/A	N/A	0.028	N/A	N/A	N/A
24	0.014	N/A	N/A	0.019	N/A	N/A	N/A
25	0.018	N/A	N/A	0.022	N/A	N/A	N/A
26	0.039	N/A	N/A	0.042	N/A	N/A	N/A
27	0.010	N/A	N/A	0.011	N/A	N/A	N/A
28	0.011	N/A	N/A	0.012	N/A	N/A	N/A
29	0.017	N/A	N/A	0.019	N/A	N/A	N/A
30	0.020	N/A	N/A	0.021	N/A	N/A	N/A
31	0.013	N/A	N/A	0.014	N/A	N/A	N/A
32	0.008	N/A	N/A	0.010	N/A	N/A	N/A
33	0.007	N/A	N/A	0.010	N/A	N/A	N/A
34	0.007	N/A	N/A	0.009	N/A	N/A	N/A
35	0.013	N/A	N/A	0.015	N/A	N/A	N/A
36	0.005	N/A	N/A	0.006	N/A	N/A	N/A
37	0.011	N/A	N/A	0.012	N/A	N/A	N/A
38	0.004	N/A	N/A	0.005	N/A	N/A	N/A
39	0.004	N/A	N/A	0.007	N/A	N/A	N/A
40	0.004	N/A	N/A	0.004	N/A	N/A	N/A

Note: Measured I-ref was applied for this test.

TEST REPORT

Harmonics – Per EN/IEC61000-3-12, Ed. 2.0(Phase B-Run time)

Test Result: Pass Source qualification: Normal

Current & voltage waveforms

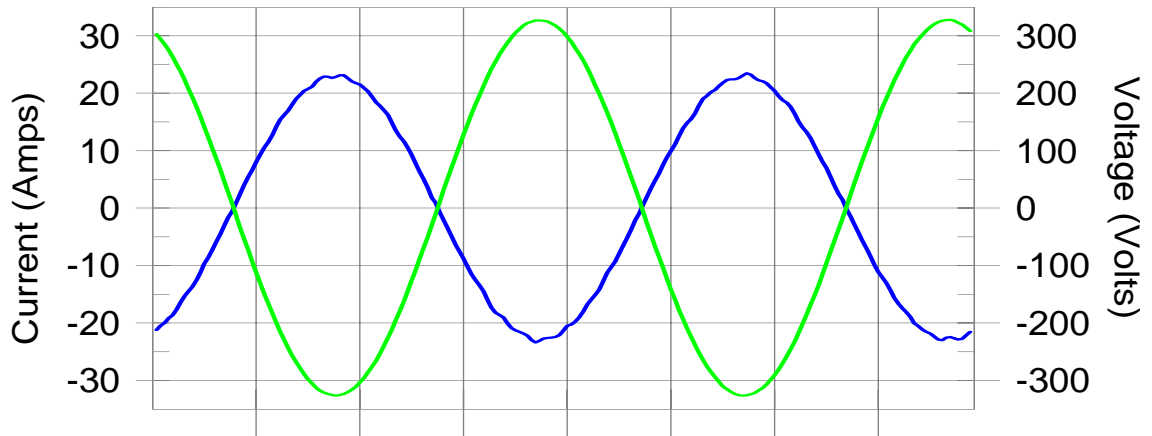

Harmonics and Class 3 limit line

European Limits

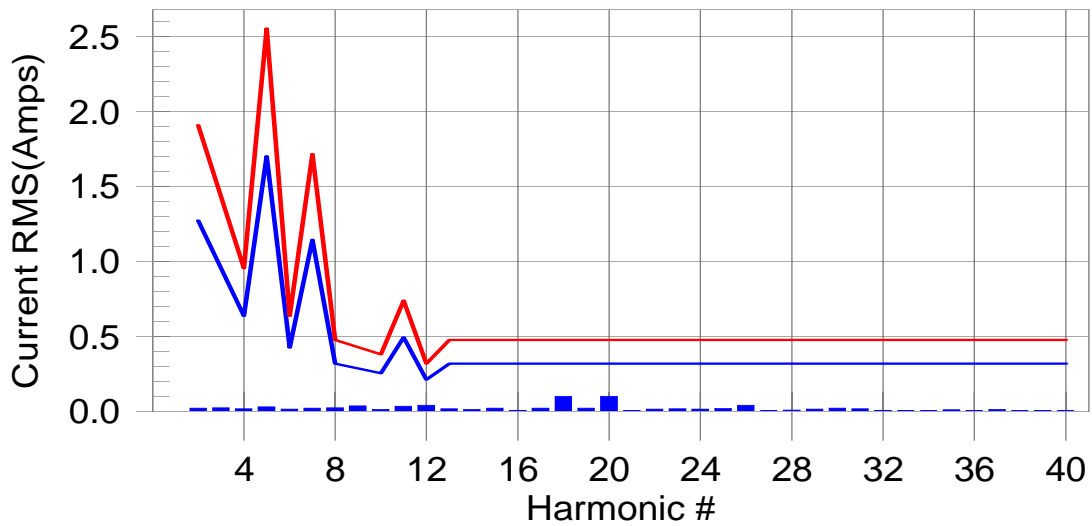

Test result: Pass Worst harmonics H12-13.9% of 150% limit, H12-19.2% of 100% limit.

TEST REPORT

Current Test Result Summary (Phase B-Run time)

Test Result: Pass Measured Iref: 15.909(Amps) Source: Normal
 THC/Iref (%): 0.0 Limit (%): 13.0 PWHC/Iref (%): 0.0 PWHC Limit (%): 22.0

Highest parameter values during test:

V_RMS (Volts): 231.34 Frequency (Hz): 50.00
 I_Peak (Amps): 23.876 I_RMS (Amps): 16.212
 I_Fund (Amps): 15.907(avg) Crest Factor: 1.497
 Power (Watts): -3774 Power Factor: -1.000

Harm#	Harms(avg)	100%Limit	%of Limit	Harms(max)	150%Limit	%of Limit	Status
2	0.021	1.273	1.7	0.025	1.909	1.3	Pass
3	0.062	N/A	N/A	0.028	N/A	N/A	N/A
4	0.017	0.636	2.7	0.020	0.955	2.1	Pass
5	0.030	1.702	1.8	0.035	2.553	1.4	Pass
6	0.016	0.424	3.8	0.018	0.636	2.9	Pass
7	0.023	1.145	2.0	0.026	1.718	1.5	Pass
8	0.024	0.318	7.5	0.026	0.477	5.5	Pass
9	0.036	N/A	N/A	0.045	N/A	N/A	N/A
10	0.012	0.255	4.7	0.013	0.382	3.5	Pass
11	0.036	0.493	7.2	0.041	0.740	5.6	Pass
12	0.041	0.212	19.2	0.044	0.318	13.9	Pass
13	0.019	0.318	6.0	0.021	0.477	4.4	Pass
14	0.013	N/A	N/A	0.015	N/A	N/A	N/A
15	0.021	N/A	N/A	0.025	N/A	N/A	N/A
16	0.008	N/A	N/A	0.009	N/A	N/A	N/A
17	0.023	N/A	N/A	0.031	N/A	N/A	N/A
18	0.101	N/A	N/A	0.105	N/A	N/A	N/A
19	0.021	N/A	N/A	0.028	N/A	N/A	N/A
20	0.100	N/A	N/A	0.105	N/A	N/A	N/A
21	0.007	N/A	N/A	0.009	N/A	N/A	N/A
22	0.015	N/A	N/A	0.019	N/A	N/A	N/A
23	0.018	N/A	N/A	0.025	N/A	N/A	N/A
24	0.016	N/A	N/A	0.020	N/A	N/A	N/A
25	0.020	N/A	N/A	0.026	N/A	N/A	N/A
26	0.042	N/A	N/A	0.044	N/A	N/A	N/A
27	0.005	N/A	N/A	0.007	N/A	N/A	N/A
28	0.010	N/A	N/A	0.012	N/A	N/A	N/A
29	0.015	N/A	N/A	0.016	N/A	N/A	N/A
30	0.023	N/A	N/A	0.025	N/A	N/A	N/A
31	0.017	N/A	N/A	0.018	N/A	N/A	N/A
32	0.008	N/A	N/A	0.010	N/A	N/A	N/A
33	0.005	N/A	N/A	0.006	N/A	N/A	N/A
34	0.005	N/A	N/A	0.007	N/A	N/A	N/A
35	0.011	N/A	N/A	0.013	N/A	N/A	N/A
36	0.005	N/A	N/A	0.006	N/A	N/A	N/A
37	0.014	N/A	N/A	0.015	N/A	N/A	N/A
38	0.004	N/A	N/A	0.005	N/A	N/A	N/A
39	0.004	N/A	N/A	0.005	N/A	N/A	N/A
40	0.004	N/A	N/A	0.004	N/A	N/A	N/A

Note: Measured I-ref was applied for this test.

TEST REPORT

Harmonics – Per EN/IEC61000-3-12, Ed. 2.0(Phase C-Run time)

Test Result: Pass Source qualification: Normal

Current & voltage waveforms

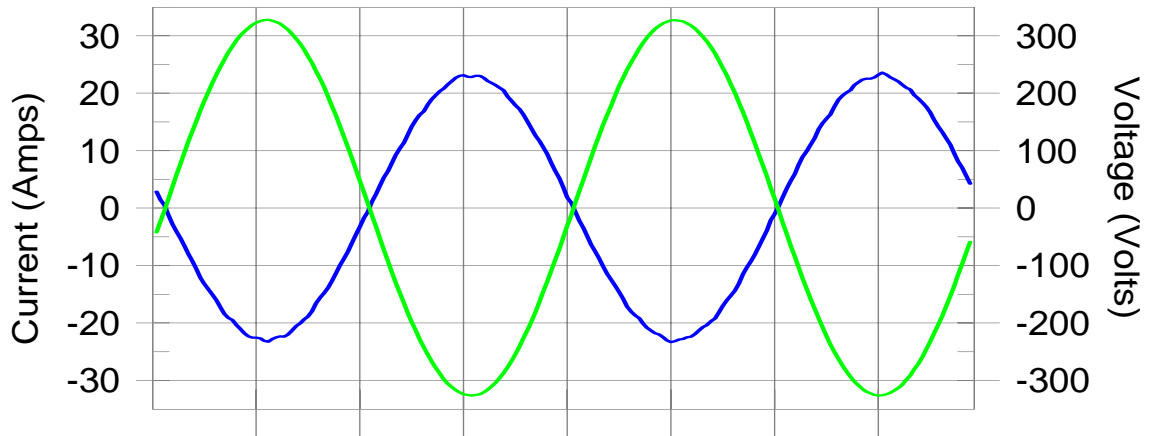

Harmonics and Class 3 limit line

European Limits

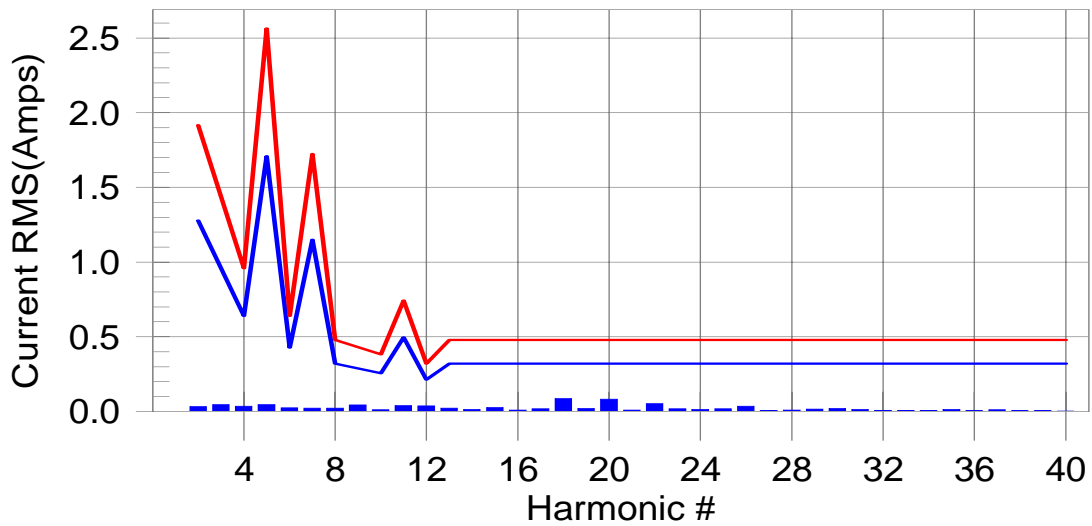

Test result: Pass Worst harmonics H12-12.9% of 150% limit, H12-17.9% of 100% limit.

TEST REPORT

Current Test Result Summary (Phase C-Run time)

Test Result: Pass Measured Iref: 15.971(Amps) Source: Normal
 THC/Iref (%): 0.0 Limit (%): 13.0 PWHC/Iref (%): 0.0 PWHC Limit (%): 22.0

Highest parameter values during test:

V_RMS (Volts): 231.37 Frequency (Hz): 50.00
 I_Peak (Amps): 25.940 I_RMS (Amps): 16.270
 I_Fund (Amps): 15.969(avg) Crest Factor: 1.624
 Power (Watts): -3789 Power Factor: -1.000

Harm#	Harms(avg)	100%Limit	%of Limit	Harms(max)	150%Limit	%of Limit	Status
2	0.032	1.278	2.5	0.034	1.917	1.8	Pass
3	0.062	N/A	N/A	0.050	N/A	N/A	N/A
4	0.035	0.639	5.5	0.038	0.958	3.9	Pass
5	0.047	1.709	2.7	0.051	2.563	2.0	Pass
6	0.025	0.426	5.9	0.028	0.639	4.3	Pass
7	0.021	1.150	1.8	0.023	1.725	1.3	Pass
8	0.023	0.319	7.1	0.026	0.479	5.3	Pass
9	0.036	N/A	N/A	0.051	N/A	N/A	N/A
10	0.011	0.256	4.5	0.013	0.383	3.4	Pass
11	0.040	0.495	8.1	0.047	0.743	6.3	Pass
12	0.038	0.213	17.9	0.041	0.319	12.9	Pass
13	0.021	0.319	6.5	0.023	0.479	4.7	Pass
14	0.014	N/A	N/A	0.016	N/A	N/A	N/A
15	0.027	N/A	N/A	0.032	N/A	N/A	N/A
16	0.009	N/A	N/A	0.012	N/A	N/A	N/A
17	0.018	N/A	N/A	0.025	N/A	N/A	N/A
18	0.087	N/A	N/A	0.092	N/A	N/A	N/A
19	0.020	N/A	N/A	0.028	N/A	N/A	N/A
20	0.083	N/A	N/A	0.088	N/A	N/A	N/A
21	0.010	N/A	N/A	0.012	N/A	N/A	N/A
22	0.053	N/A	N/A	0.062	N/A	N/A	N/A
23	0.018	N/A	N/A	0.025	N/A	N/A	N/A
24	0.013	N/A	N/A	0.022	N/A	N/A	N/A
25	0.017	N/A	N/A	0.024	N/A	N/A	N/A
26	0.035	N/A	N/A	0.037	N/A	N/A	N/A
27	0.008	N/A	N/A	0.010	N/A	N/A	N/A
28	0.009	N/A	N/A	0.010	N/A	N/A	N/A
29	0.016	N/A	N/A	0.019	N/A	N/A	N/A
30	0.020	N/A	N/A	0.023	N/A	N/A	N/A
31	0.013	N/A	N/A	0.015	N/A	N/A	N/A
32	0.008	N/A	N/A	0.009	N/A	N/A	N/A
33	0.007	N/A	N/A	0.011	N/A	N/A	N/A
34	0.007	N/A	N/A	0.009	N/A	N/A	N/A
35	0.013	N/A	N/A	0.015	N/A	N/A	N/A
36	0.005	N/A	N/A	0.006	N/A	N/A	N/A
37	0.011	N/A	N/A	0.013	N/A	N/A	N/A
38	0.004	N/A	N/A	0.004	N/A	N/A	N/A
39	0.004	N/A	N/A	0.006	N/A	N/A	N/A
40	0.003	N/A	N/A	0.004	N/A	N/A	N/A

Note: Measured I-ref was applied for this test.

TEST REPORT

Model: EVVO 3000TL3P

Mode: Inverting mode with full load

Harmonics – Class-A per Ed. 4.0 (2014)(Phase A-Run time) incl. inter-harmonics

Test Result: Pass Source qualification: Normal

Current & voltage waveforms

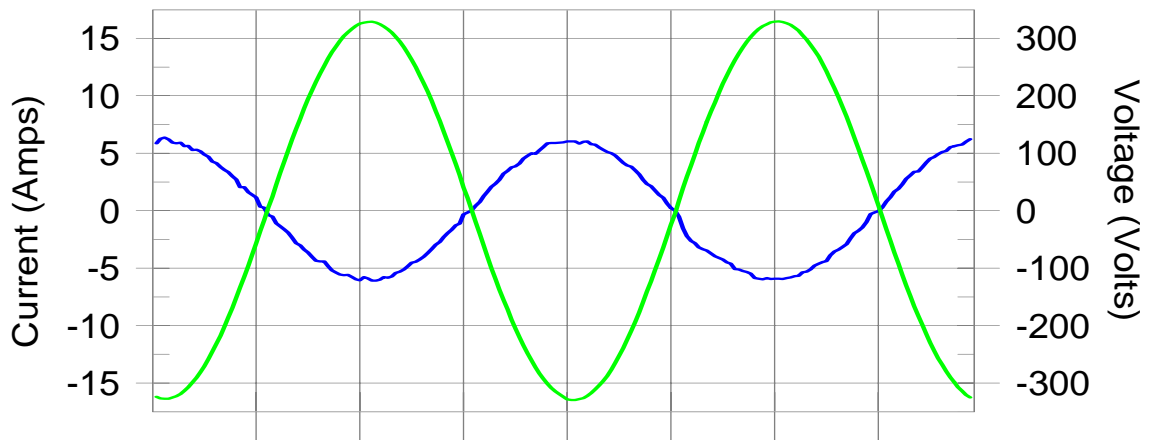

Harmonics and Class A limit line

European Limits

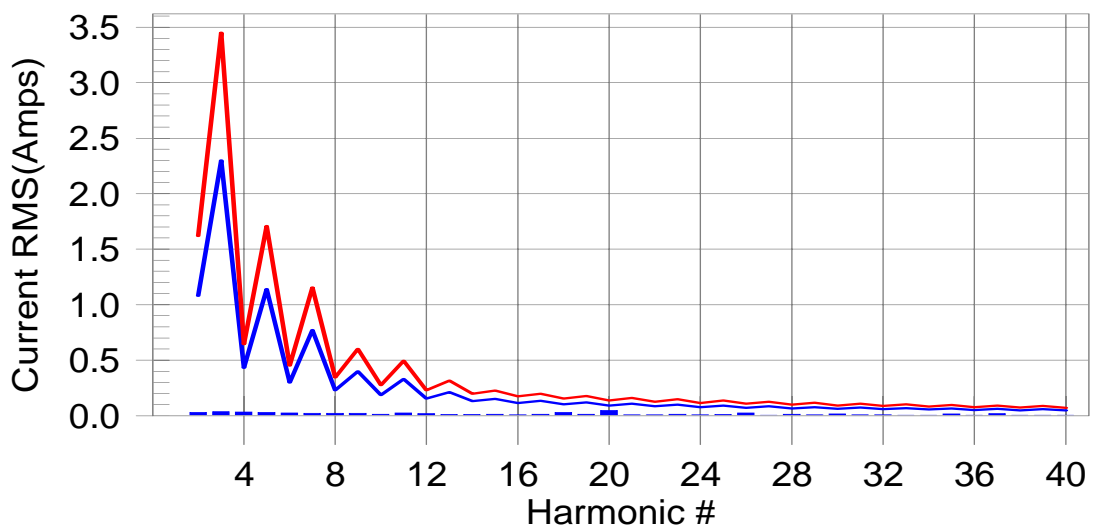

Test result: Pass Worst harmonic was #20 with 52.5% of the limit.

TEST REPORT

Current Test Result Summary (Phase A-Run time)

Test Result: Pass

Source qualification: Normal

THC: 0.117 A

I-THD: 2.7 %

POHC(A): 0.032 A

POHC Limit(A): 0.251 A

Highest parameter values during test:

V_RMS (Volts): 233.410

Frequency(Hz): 50.00

I_Peak (Amps): 6.618

I_RMS (Amps): 4.283

I_Fund (Amps): 4.280

Crest Factor: 1.549

Power (Watts): -991.9

Power Factor: -0.999

Harm#	Harms(avg)	100%Limit	%of Limit	Harms(max)	150%Limit	%of Limit	Status
2	0.031	1.080	2.9	0.032	1.620	2.0	Pass
3	0.037	2.300	1.6	0.038	3.450	1.1	Pass
4	0.032	0.430	7.4	0.034	0.645	5.2	Pass
5	0.031	1.140	2.7	0.032	1.710	1.9	Pass
6	0.024	0.300	8.0	0.026	0.450	5.7	Pass
7	0.021	0.770	2.8	0.023	1.155	2.0	Pass
8	0.021	0.230	9.3	0.024	0.345	6.9	Pass
9	0.022	0.400	5.4	0.024	0.600	4.0	Pass
10	0.014	0.184	7.7	0.016	0.276	5.6	Pass
11	0.025	0.330	7.5	0.027	0.495	5.4	Pass
12	0.017	0.153	11.3	0.019	0.230	8.4	Pass
13	0.010	0.210	5.0	0.012	0.315	3.7	Pass
14	0.009	0.131	6.8	0.011	0.197	5.4	Pass
15	0.011	0.150	7.6	0.012	0.225	5.5	Pass
16	0.008	0.115	6.6	0.009	0.173	5.3	Pass
17	0.014	0.132	10.6	0.015	0.198	7.6	Pass
18	0.031	0.102	30.5	0.033	0.153	21.6	Pass
19	0.014	0.118	11.7	0.015	0.178	8.5	Pass
20	0.048	0.092	52.5	0.050	0.138	36.5	Pass
21	0.006	0.107	5.8	0.007	0.161	4.5	Pass
22	0.005	0.084	6.5	0.007	0.125	5.4	Pass
23	0.014	0.098	14.4	0.015	0.147	10.5	Pass
24	0.007	0.077	8.5	0.008	0.115	6.9	Pass
25	0.010	0.090	11.5	0.012	0.135	8.6	Pass
26	0.023	0.071	32.5	0.025	0.107	23.1	Pass
27	0.005	0.083	N/A	0.006	0.125	N/A	Pass
28	0.012	0.066	18.0	0.013	0.099	13.3	Pass
29	0.008	0.078	10.4	0.009	0.116	7.8	Pass
30	0.016	0.061	26.2	0.017	0.092	18.8	Pass
31	0.008	0.073	11.1	0.009	0.109	8.4	Pass
32	0.007	0.058	12.2	0.008	0.086	9.2	Pass
33	0.003	0.068	N/A	0.004	0.102	N/A	Pass
34	0.004	0.054	N/A	0.005	0.081	N/A	Pass
35	0.015	0.064	23.1	0.017	0.096	17.2	Pass
36	0.005	0.051	N/A	0.005	0.077	N/A	Pass
37	0.018	0.061	28.8	0.019	0.091	20.4	Pass
38	0.002	0.048	N/A	0.003	0.073	N/A	Pass
39	0.004	0.058	N/A	0.006	0.087	N/A	Pass
40	0.004	0.046	N/A	0.005	0.069	N/A	Pass

TEST REPORT

Harmonics – Class-A per Ed. 4.0 (2014)(Phase B-Run time) incl. inter-harmonics

Test Result: Pass Source qualification: Normal

Current & voltage waveforms

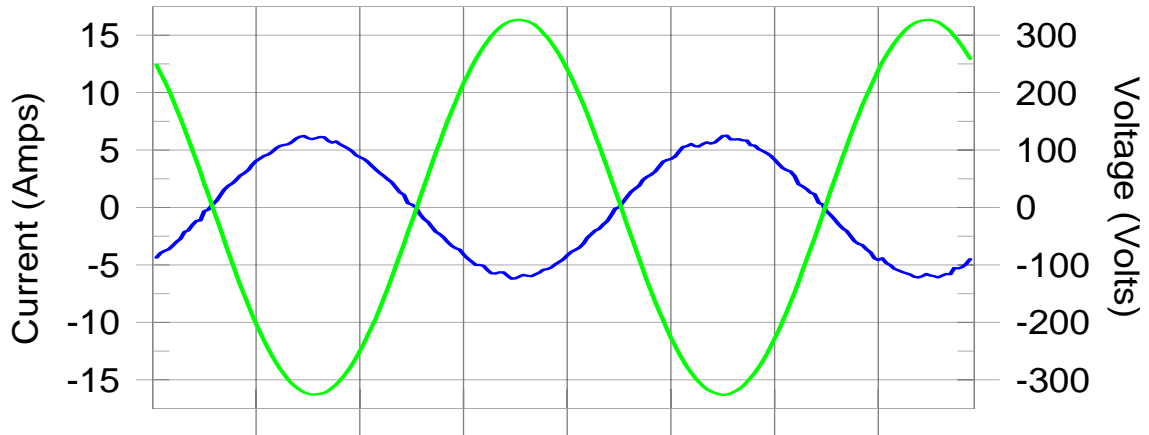

Harmonics and Class A limit line

European Limits

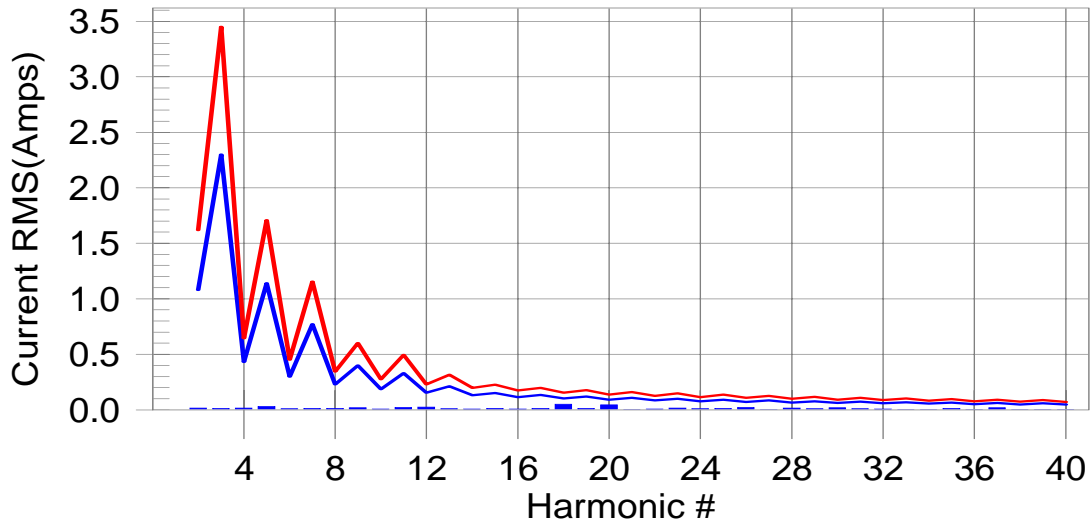

Test result: Pass Worst harmonic was #18 with 49.6% of the limit.

TEST REPORT

Current Test Result Summary (Phase B-Run time)

Test Result: Pass Source qualification: Normal
 THC: 0.105 A I-THD: 2.5 % POHC(A): 0.033 A POHC Limit(A): 0.251 A
 Highest parameter values during test:

V_RMS (Volts):	230.993	Frequency(Hz):	50.00
I_Peak (Amps):	6.522	I_RMS (Amps):	4.285
I_Fund (Amps):	4.283	Crest Factor:	1.525
Power (Watts):	-988.3	Power Factor:	-0.999

Harm#	Harms(avg)	100%Limit	%of Limit	Harms(max)	150%Limit	%of Limit	Status
2	0.015	1.080	1.4	0.016	1.620	1.0	Pass
3	0.014	2.300	0.6	0.016	3.450	0.5	Pass
4	0.015	0.430	3.6	0.017	0.645	2.6	Pass
5	0.030	1.140	2.6	0.031	1.710	1.8	Pass
6	0.011	0.300	3.8	0.012	0.450	2.8	Pass
7	0.014	0.770	1.8	0.015	1.155	1.3	Pass
8	0.014	0.230	5.9	0.021	0.345	6.0	Pass
9	0.018	0.400	4.4	0.019	0.600	3.1	Pass
10	0.007	0.184	4.0	0.009	0.276	3.2	Pass
11	0.020	0.330	6.1	0.021	0.495	4.3	Pass
12	0.024	0.153	16.0	0.026	0.230	11.2	Pass
13	0.009	0.210	4.4	0.011	0.315	3.6	Pass
14	0.008	0.131	6.0	0.011	0.197	5.6	Pass
15	0.012	0.150	7.8	0.013	0.225	5.6	Pass
16	0.007	0.115	6.5	0.008	0.173	4.9	Pass
17	0.013	0.132	9.6	0.014	0.198	7.0	Pass
18	0.051	0.102	49.6	0.052	0.153	34.0	Pass
19	0.013	0.118	10.8	0.014	0.178	8.1	Pass
20	0.045	0.092	48.7	0.046	0.138	33.5	Pass
21	0.004	0.107	N/A	0.006	0.161	N/A	Pass
22	0.006	0.084	6.6	0.007	0.125	5.3	Pass
23	0.016	0.098	16.1	0.017	0.147	11.5	Pass
24	0.008	0.077	10.9	0.009	0.115	8.0	Pass
25	0.012	0.090	13.7	0.014	0.135	10.2	Pass
26	0.021	0.071	29.5	0.022	0.107	20.7	Pass
27	0.004	0.083	N/A	0.005	0.125	N/A	Pass
28	0.015	0.066	22.8	0.016	0.099	15.7	Pass
29	0.009	0.078	11.8	0.010	0.116	8.5	Pass
30	0.018	0.061	29.2	0.019	0.092	20.3	Pass
31	0.009	0.073	12.3	0.010	0.109	9.2	Pass
32	0.006	0.058	10.4	0.007	0.086	7.7	Pass
33	0.003	0.068	N/A	0.004	0.102	N/A	Pass
34	0.004	0.054	N/A	0.005	0.081	N/A	Pass
35	0.014	0.064	22.5	0.016	0.096	16.2	Pass
36	0.005	0.051	N/A	0.005	0.077	N/A	Pass
37	0.018	0.061	30.2	0.020	0.091	21.7	Pass
38	0.002	0.048	N/A	0.003	0.073	N/A	Pass
39	0.003	0.058	N/A	0.004	0.087	N/A	Pass
40	0.005	0.046	N/A	0.005	0.069	N/A	Pass

TEST REPORT

Harmonics – Class-A per Ed. 4.0 (2014)(Phase C-Run time) incl. inter-harmonics

Test Result: Pass Source qualification: Normal

Current & voltage waveforms

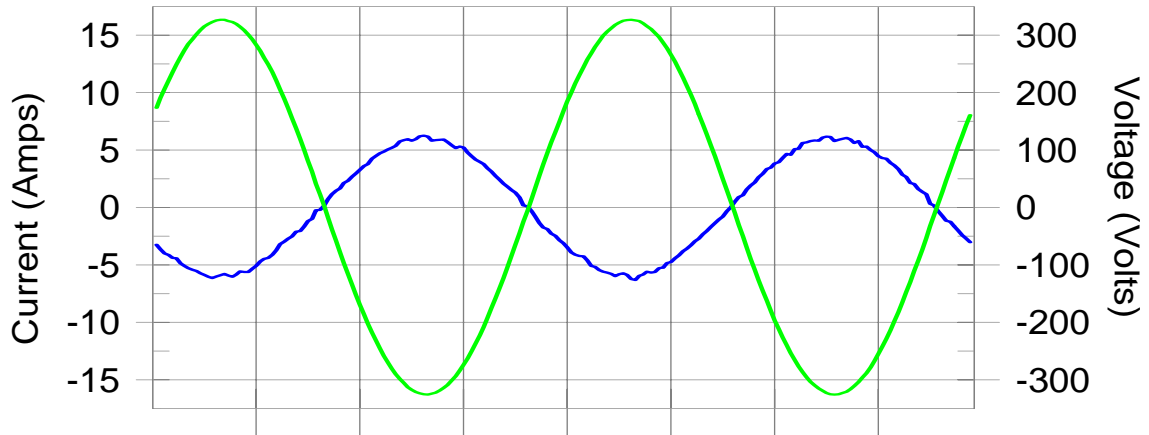

Harmonics and Class A limit line

European Limits

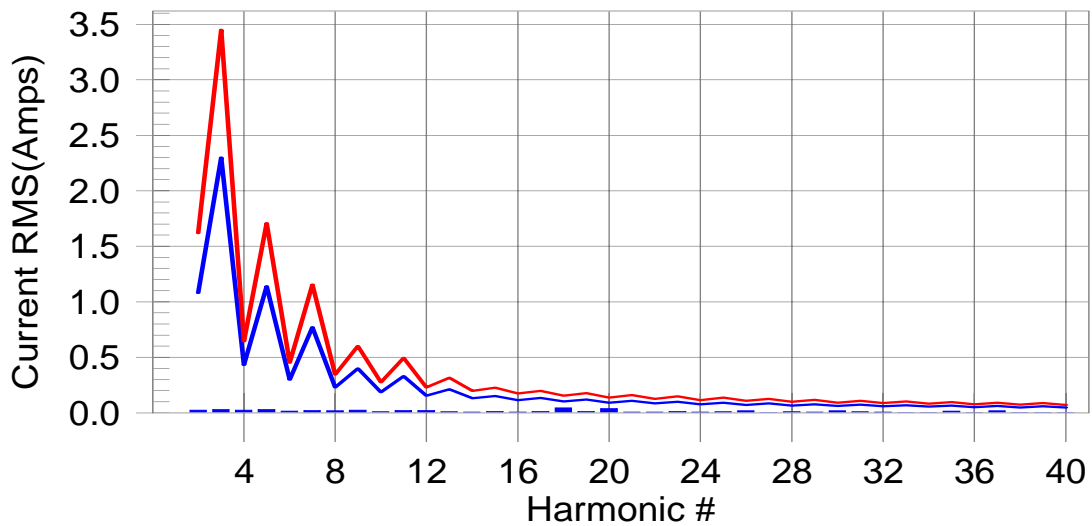

Test result: Pass Worst harmonic was #18 with 44.5% of the limit.

TEST REPORT

Current Test Result Summary (Phase C-Run time)

Test Result: Pass Source qualification: Normal
 THC: 0.108 A I-THD: 2.5 % POHC(A): 0.032 A POHC Limit(A): 0.251 A
 Highest parameter values during test:
 V_RMS (Volts): 230.765 Frequency(Hz): 50.00
 I_Peak (Amps): 6.470 I_RMS (Amps): 4.269
 I_Fund (Amps): 4.266 Crest Factor: 1.520
 Power (Watts): -983.6 Power Factor: -0.999

Harm#	Harms(avg)	100%Limit	%of Limit	Harms(max)	150%Limit	%of Limit	Status
2	0.023	1.080	2.2	0.024	1.620	1.5	Pass
3	0.028	2.300	1.2	0.030	3.450	0.9	Pass
4	0.023	0.430	5.4	0.025	0.645	3.8	Pass
5	0.031	1.140	2.7	0.032	1.710	1.9	Pass
6	0.017	0.300	5.5	0.018	0.450	4.1	Pass
7	0.022	0.770	2.8	0.023	1.155	2.0	Pass
8	0.017	0.230	7.4	0.019	0.345	5.5	Pass
9	0.023	0.400	5.9	0.024	0.600	4.1	Pass
10	0.010	0.184	5.7	0.012	0.276	4.5	Pass
11	0.021	0.330	6.2	0.023	0.495	4.7	Pass
12	0.022	0.153	14.3	0.024	0.230	10.3	Pass
13	0.011	0.210	5.3	0.013	0.315	4.1	Pass
14	0.007	0.131	5.1	0.008	0.197	4.2	Pass
15	0.014	0.150	9.4	0.015	0.225	6.7	Pass
16	0.006	0.115	5.2	0.008	0.173	4.8	Pass
17	0.012	0.132	8.9	0.013	0.198	6.3	Pass
18	0.045	0.102	44.5	0.047	0.153	30.7	Pass
19	0.013	0.118	10.8	0.014	0.178	7.9	Pass
20	0.038	0.092	41.5	0.040	0.138	28.7	Pass
21	0.006	0.107	5.9	0.008	0.161	5.0	Pass
22	0.006	0.084	7.3	0.007	0.125	5.8	Pass
23	0.014	0.098	14.5	0.016	0.147	10.6	Pass
24	0.008	0.077	9.9	0.008	0.115	7.4	Pass
25	0.011	0.090	12.2	0.013	0.135	9.3	Pass
26	0.018	0.071	25.4	0.019	0.107	17.8	Pass
27	0.004	0.083	N/A	0.005	0.125	N/A	Pass
28	0.011	0.066	16.5	0.012	0.099	12.1	Pass
29	0.008	0.078	10.4	0.009	0.116	8.1	Pass
30	0.017	0.061	28.4	0.018	0.092	19.8	Pass
31	0.010	0.073	13.2	0.010	0.109	9.6	Pass
32	0.006	0.058	9.8	0.007	0.086	7.6	Pass
33	0.003	0.068	N/A	0.004	0.102	N/A	Pass
34	0.004	0.054	N/A	0.005	0.081	N/A	Pass
35	0.015	0.064	22.9	0.016	0.096	16.7	Pass
36	0.004	0.051	N/A	0.005	0.077	N/A	Pass
37	0.017	0.061	27.8	0.018	0.091	19.6	Pass
38	0.003	0.048	N/A	0.003	0.073	N/A	Pass
39	0.004	0.058	N/A	0.006	0.087	N/A	Pass
40	0.004	0.046	N/A	0.004	0.069	N/A	Pass

TEST REPORT

7. Flicker

Test Result: Pass

7.1 Block Diagram of Test Setup

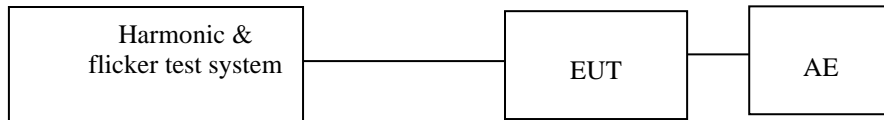

7.2 Test Setup and Procedure

7.2.1 Definition

Flicker:	impression of unsteadiness of visual sensation induced by a lighting stimulus whose luminance or spectral distribution fluctuates with time.
Pst:	Short-term flicker indicator The flicker severity evaluated over a short period (in minutes); Pst=1 is the conventional threshold of irritability
Plt:	long-term flicker indicator; the flicker severity evaluated over a long period (a few hours). Using successive Pst value.
dc:	the relative steady-state voltage change
dmax:	the maximum relative voltage change
d(t):	the value during a voltage change

7.2.2 Test condition

The EUT was set to produce the most unfavourable sequence of voltage changes.

TEST REPORT

7.3 Test Data

Model: EVVO 3000TL3P

Flicker Test Summary per EN/IEC61000-3-3 (Phase A-Run time)

Test Result: Pass

Status: Test Completed

Parameter values recorded during the test:

Vrms at the end of test (Volt):	232.19			
Highest dt (%):	0.00	Test limit (%):	N/A	N/A
T-max (mS):	0.0	Test limit (mS):	500.0	Pass
Highest dc (%):	0.00	Test limit (%):	3.30	Pass
Highest dmax (%):	-0.09	Test limit (%):	4.00	Pass
Highest Pst (10 min. period):	0.064	Test limit:	1.000	Pass
Highest Plt (2 hr. period):	0.028	Test limit:	0.650	Pass

Flicker Test Summary per EN/IEC61000-3-3 (Phase B-Run time)

Test Result: Pass

Status: Test Completed

Parameter values recorded during the test:

Vrms at the end of test (Volt):	231.76			
Highest dt (%):	0.00	Test limit (%):	N/A	N/A
Tmax(mS) > dt:	0.0	Test limit (mS):	500.0	Pass
Highest dc (%):	0.00	Test limit (%):	3.30	Pass
Highest dmax (%):	-0.11	Test limit (%):	4.00	Pass
Highest Pst (10 min. period):	0.305	Test limit:	1.000	Pass
Highest Plt (2 hr. period):	0.133	Test limit:	0.650	Pass

TEST REPORT

Flicker Test Summary per EN/IEC61000-3-3 (Phase C-Run time)

Test Result: Pass

Status: Test Completed

Parameter values recorded during the test:

Vrms at the end of test (Volt):	231.72			
Highest dt (%):	0.00	Test limit (%):	N/A	N/A
Tmax(mS) > dt:	0.0	Test limit (mS):	500.0	Pass
Highest dc (%):	0.00	Test limit (%):	3.30	Pass
Highest dmax (%):	0.09	Test limit (%):	4.00	Pass
Highest Pst (10 min. period):	0.242	Test limit:	1.000	Pass
Highest Plt (2 hr. period):	0.106	Test limit:	0.650	Pass

TEST REPORT

Model: EVVO 12000TL3P

Flicker Test Summary Per EN/IEC61000-3-11, Ed. 1.0(Phase A-Run time) per EN/IEC61000-3-11 IEC61000-3-11 Ed. 1.0 (2000)

Z-test Phase = (0.150 + j 0.150 Ohm) Neutral = (0.100 + j 0.100 Ohm)

Test Result: Pass
Status: Test Completed

Parameter values recorded during the test:

Vrms at the end of test (Volt): 234.98

T-max (mS):	0.0	Test limit (mS):	500.0	Pass
Highest dc (%):	0.00	Test limit (%):	3.30	Pass
Highest dmax (%):	-0.24	Test limit (%):	4.00	Pass
Highest Pst (10 min. period):	0.217	Test limit:	1.000	Pass
Highest Plt (2 hr. period):	0.095	Test limit:	0.650	Pass

Calculated dmax(%): 0.000
Calculated dc(%): 0.000
Calculated Pst : 0.289
Calculated Plt : 0.126

The maximum permissible system impedance Zsys:

Z-phase A = 1.543 Ohm + j 0.964 Ohm (1.543 Ohm + 3069 ?H)
Z-neutral A = 1.029 Ohm + j 0.643 Ohm (1.029 Ohm + 2046 ?H)

TEST REPORT

Flicker Test Summary Per EN/IEC61000-3-11, Ed. 1.0(Phase B-Run time) per EN/IEC61000-3-11

Z-test Phase = (0.150 + j 0.150 Ohm) Neutral = (0.100 + j 0.100 Ohm)

Test Result: Pass

Status: Test Completed

Parameter values recorded during the test:

Vrms at the end of test (Volt): 235.06

Time(mS) > dt:	0.0	Test limit (mS):	500.0	Pass
Highest dc (%):	0.00	Test limit (%):	3.30	Pass
Highest dmax (%):	-0.23	Test limit (%):	4.00	Pass
Highest Pst (10 min. period):	0.227	Test limit:	1.000	Pass
Highest Plt (2 hr. period):	0.099	Test limit:	0.650	Pass

Calculated dmax(%): 0.000

Calculated dc(%): 0.000

Calculated Pst : 0.303

Calculated Plt : 0.132

The maximum permissible system impedance Zsys :

Z-phase B = 1.441 Ohm + j 0.901 Ohm (1.441 Ohm + 2867 ?H)
Z-neutral B = 0.961 Ohm + j 0.600 Ohm (0.961 Ohm + 1911 ?H)

TEST REPORT

Flicker Test Summary Per EN/IEC61000-3-11, Ed. 1.0(Phase C-Run time) per EN/IEC61000-3-11

Z-test Phase = (0.150 + j 0.150 Ohm) Neutral = (0.100 + j 0.100 Ohm)

Test Result: Pass
Status: Test Completed

Parameter values recorded during the test:

Vrms at the end of test (Volt): 234.80

Time(mS) > dt:	0.0	Test limit (mS):	500.0	Pass
Highest dc (%):	0.00	Test limit (%):	3.30	Pass
Highest dmax (%):	-0.27	Test limit (%):	4.00	Pass
Highest Pst (10 min. period):	0.220	Test limit:	1.000	Pass
Highest Plt (2 hr. period):	0.096	Test limit:	0.650	Pass

Calculated dmax(%): 0.000
Calculated dc(%): 0.000
Calculated Pst : 0.293
Calculated Plt : 0.128

The maximum permissible system impedance Zsys :

Z-phase C = 1.511 Ohm + j 0.944 Ohm (1.511 Ohm + 3006 ?H)
Z-neutral C = 1.007 Ohm + j 0.630 Ohm (1.007 Ohm + 2004 ?H)

TEST REPORT

8. EMS TEST

Performance Criteria:

- Criterion A: The apparatus shall continue to operate as intended during the test. No degradation of performance or loss of function is allowed below a performance level (or permission loss of performance) specified by the manufacturer, when the apparatus is used as intended. If the minimum performance level or the permissible performance loss is not specified by the manufacturer, then either of these may be derived from the product description and documentation and from what the user may reasonably expect from the apparatus if used as intended.
- Criterion B: The apparatus shall continue to operate as intended after the test. No degradation of performance or loss of function is allowed below a performance level (or permission loss of performance) specified by the manufacturer, when the apparatus is used as intended. During the test, degradation of performance is allowed, however, no change of actual operating state or stored data is allowed. If the minimum performance level or the permissible performance loss is not specified by the manufacturer, then either of these may be derived from the product description, and documentation, and from what the user may reasonably expect from the apparatus if used as intended.
- Criterion C: Temporary loss of function is allowed, provided the function is self-recoverable or can be restored by the operation of the controls, or by any operation specified in the instruction for use.

Operation mode of EMS test:

Test Item	Operation mode
ESD immunity	Inverting mode with lighting load
Radiated EM field immunity	
EFT immunity	
Surge immunity	
Inject current immunity	
Power frequency magnetic field immunity	
Voltage dips and interruption immunity	N/A

Note: "N/A" means Not Applicable in below text.

8.1 EN 61000-4-2(Pursuant to EN 61000-6-1) Electrostatic Discharge Immunity

Performance criterion: B

Test Result: Pass

TEST REPORT

8.1.1 Block Diagram of Test Setup

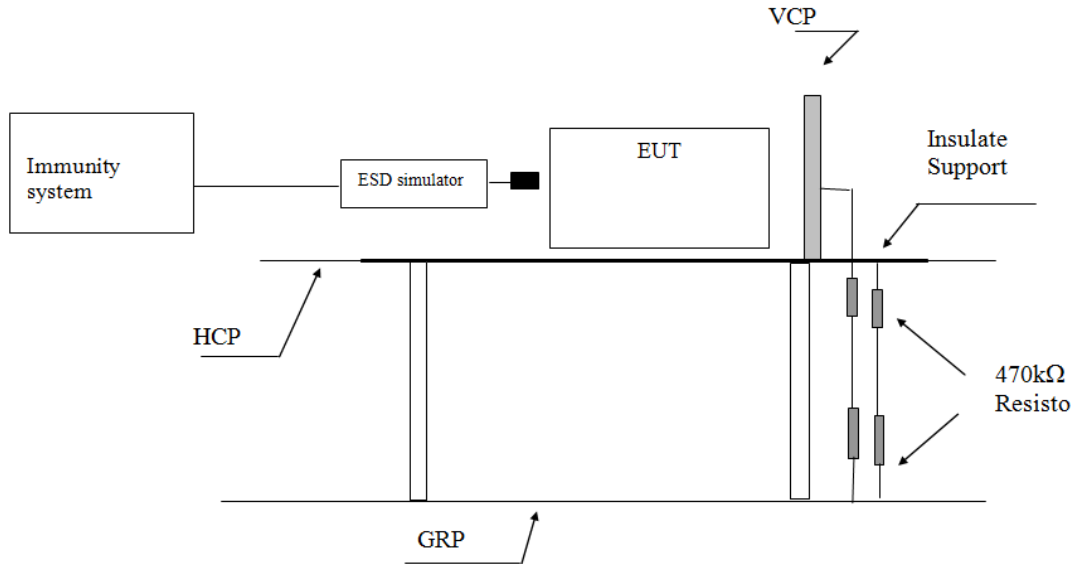

Note: HCP means Horizontal Coupling Plane,

VCP means Vertical Coupling Plane

GRP means Ground Reference Plane

8.1.2 Test Setup and Procedure

The EUT was put on a 0.8m high wooden table 0.1m high for floor standing equipment standing on the ground reference plane (GRP) 3m by 2m in size, made by iron 1.0 mm thick.

A horizontal coupling plane(HCP) 1.6m by 0.8m in size was placed on the table, and the EUT with its cables were isolated from the HCP by an insulating support thick than 0.5mm. The VCP 0.5m by 0.5m in size & HCP were constructed from the same material type & thickness as that of the GRP, and connected to the GRP via a 470kΩ resistor at each end.

The distance between EUT and any of the other metallic surface excepted the GRP, HCP & VCP was greater than 1m.

The EUT was arranged and connected according to its functional requirements.

Direct static electricity discharges were applied only to those points and surface which were accessible to personnel during normal usage.

TEST REPORT

On each preselected points 10 times of each polarity single discharge were applied. The time interval between successive single discharges was at least 1s.

The ESD generator was held perpendicular to the surface to which the discharge was applied. The discharge return cable of the generator was kept at a distance of 0.2m whilst the discharge was being applied. During the contact discharges, the tip of the discharge electrode was touched the EUT before the discharge switch was operated. During the air discharges, the round discharge tip of the discharge electrode was approached as fast as possible to touch the EUT.

Indirect discharge was conducted to objects placed near the EUT, simulated by applying the discharges of the ESD generator to a coupling plane, in the contact discharge mode.

After each discharge, the ESD generator was removed from the EUT, the generator was then retriggered for a new single discharge. For ungrounded product, a grounded carbon fibre brush with bleeder resistors (2x470 kΩ) in the grounding cable was used after each discharge to remove remnant electrostatic voltage.

For air discharge, a minimum of 10 single air discharges were applied to the selected test point for each such area.

8.1.3 Test Result

Direct Application of ESD

Direct Contact Discharge

Applied Voltage (kV)	No. of Discharge for each point	Result	Discharged Points
4	20	Pass	Accessible metal parts of the EUT Conductive substrate with coating which is not declared to be insulating

Direct Air Discharge

Applied Voltage (kV)	No. of Discharge for each point	Result	Discharged Points
2, 4, 8	20	Pass	All accessible points where contact discharge cannot be applied such as Displays, Indicators light, Keyboard, Button, Switch, Knob, Air gap, Slots, Hole and so on

TEST REPORT

Indirect Application of ESD

Horizontal Coupling Plane under the EUT

Applied Voltage (kV)	No. of Discharge for each point	Result	Discharged Point
4	20	Pass	At the front edge of each HCP opposite the centre point of each unit of the EUT

Vertical Coupling Plane beside the EUT

Applied Voltage (kV)	No. of Discharge for each point	Result	Discharged Point
4	20	Pass	The centre of the vertical edge of the coupling plane

8.2 EN 61000-4-6(Pursuant to EN 61000-6-1) Injected Current (0.15 MHz to 80 MHz)

Tested Port: AC power DC power Functional earth Signal/Control

Performance criterion: A

Test Result: Pass

8.2.1 Block Diagram of Test Setup

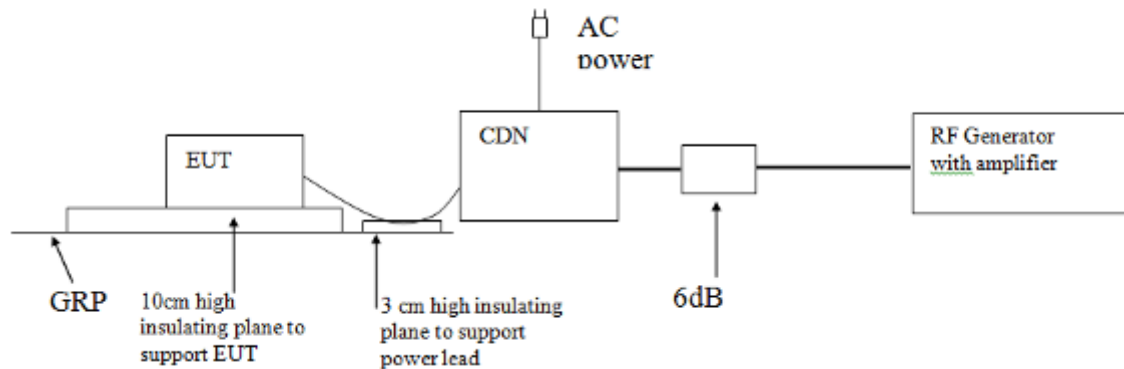

8.2.2 Test Setup and Procedure

The EUT was placed on an insulating support of 0.1m height above a ground reference Plane, arranged and connected to satisfy its functional requirement.

TEST REPORT

All relevant cables were provided with the appropriate coupling and decoupling devices at a distance between 0.1m and 0.3m from the projected geometry of the EUT on an insulating support of 0.03m height above the ground reference plane.

Test voltage was verified before each testing though power meter combined in the RF generator with AMP.

Dwell time was set to 3s and step was set as 1% to keep sufficient response time for EUT. The frequency from 0.15MHz to 80MHz was checked.

The frequency range is scanned as specified. However, when specified in Annex A of EN 61000-6-1, an additional comprehensive functional test shall be carried out at a limited number of frequencies. The selected frequencies for conducted test are: 0,2; 1; 7,1; 13,56; 21; 27,12 and 40,68 MHz (±1 %).

8.2.3 Test Result

Port	Frequency (MHz)	Level	Result
A.C. Power Lines	0.15 to 80	3V (r.m.s.)	Pass
D.C. Power Lines	0.15 to 80	3V (r.m.s.)	Pass
Signal Lines	0.15 to 80	3V (r.m.s.)	N/A
Control Lines	0.15 to 80	3V (r.m.s.)	N/A
Functional Earth	0.15 to 80	3V (r.m.s.)	N/A

8.3 EN 61000-4-4(Pursuant to EN 61000-6-1) Electrical Fast Transient/Burst

Tested Port: AC power DC power Functional earth Signal/Control

Performance criterion: B

Test Result: Pass

8.3.1 Block Diagram of Test Setup

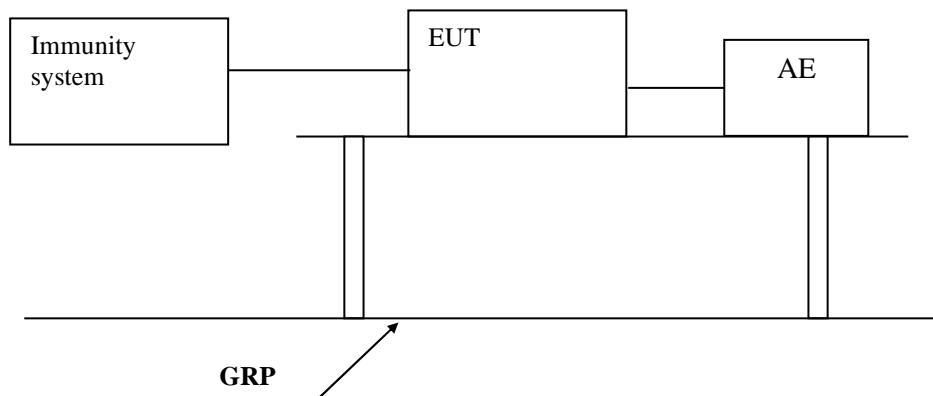

TEST REPORT

8.3.2 Test Setup and Procedure

The EUT was placed on a 0.1m high wooden table, standing on the ground reference plane 3m by 2m in size, made by steel 1mm thick.

The distance between the EUT and any other of the metallic surface except the GRP was greater than 0.5m.

The mains lead excess than 0.5m was folded to avoid a flat coil and situated at a distance of 0.1m above the ground reference plane to insure the distance between the coupling device and the EUT was 0.5m.

The EUT was arranged and connected to satisfy its functional requirement and supplied by the coupling-decoupling network. Repetition Frequency was 5 kHz.

8.3.3 Test Result

Level	Polarity	A.C. Power supply line and functional earth terminal	D.C. Power Lines, Signal Line & Control Line
0.5 kV	+	N/A	Pass
0.5 kV	-	N/A	Pass
1 kV	+	Pass	N/A
1 kV	-	Pass	N/A

8.4 EN 61000-4-5(Pursuant to EN 61000-6-1) Surge Immunity

Tested Port: AC power DC power

Performance criterion: B

Test Result: Pass

8.4.1 Block Diagram of Test Setup

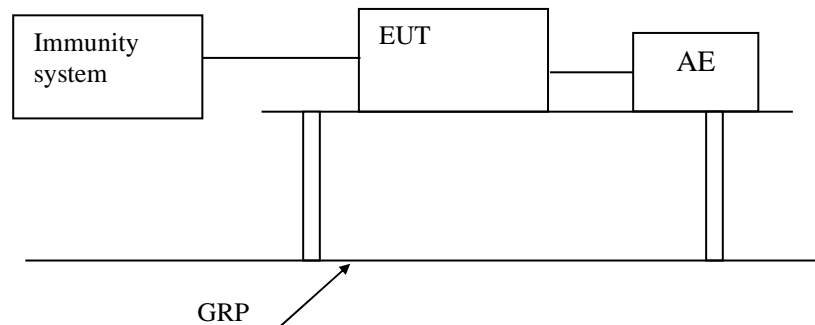

8.4.2 Test Setup and Procedure

TEST REPORT

The surge was applied to the EUT power supply terminals via the capacitive coupling network.

Decoupling networks were required in order to avoid possible adverse effects on equipment not under test that might be powered by the same lines and to provide sufficient decoupling impedance to the surge wave so that the specified wave might be developed on the lines under test.

The EUT was arranged and connected according to its functional requirements.

The EUT was placed on a 0.1m high wooden support above the GRP), supplied by the coupling-decoupling network, and arranged and connected to satisfy its functional requirement. The power cord between the EUT and the coupling/decoupling network was less than 2 meters.

8.4.3 Test Result

Tested Port	Level	Result
AC power	Line to line $\pm 0.5\text{kV}$, $\pm 1\text{kV}$	Pass
AC power	Line to earth $\pm 0.5\text{kV}$, $\pm 1\text{kV}$, $\pm 2\text{kV}$	Pass
DC power	Line to earth $\pm 0.5\text{kV}$	N/A

8.5 EN 61000-4-11(Pursuant to EN 61000-6-1) Voltage Dips and Interruptions

Tested Port: AC power

Test Result: Not Applicable

Remark: the test only applicable to the AC input port.

TEST REPORT

8.6 EN 61000-4-3(Pursuant to EN 61000-6-1) Radiated Electromagnetic Field Immunity

Performance criterion: A

Test Result: Pass

8.6.1 Block Diagram of Test Setup

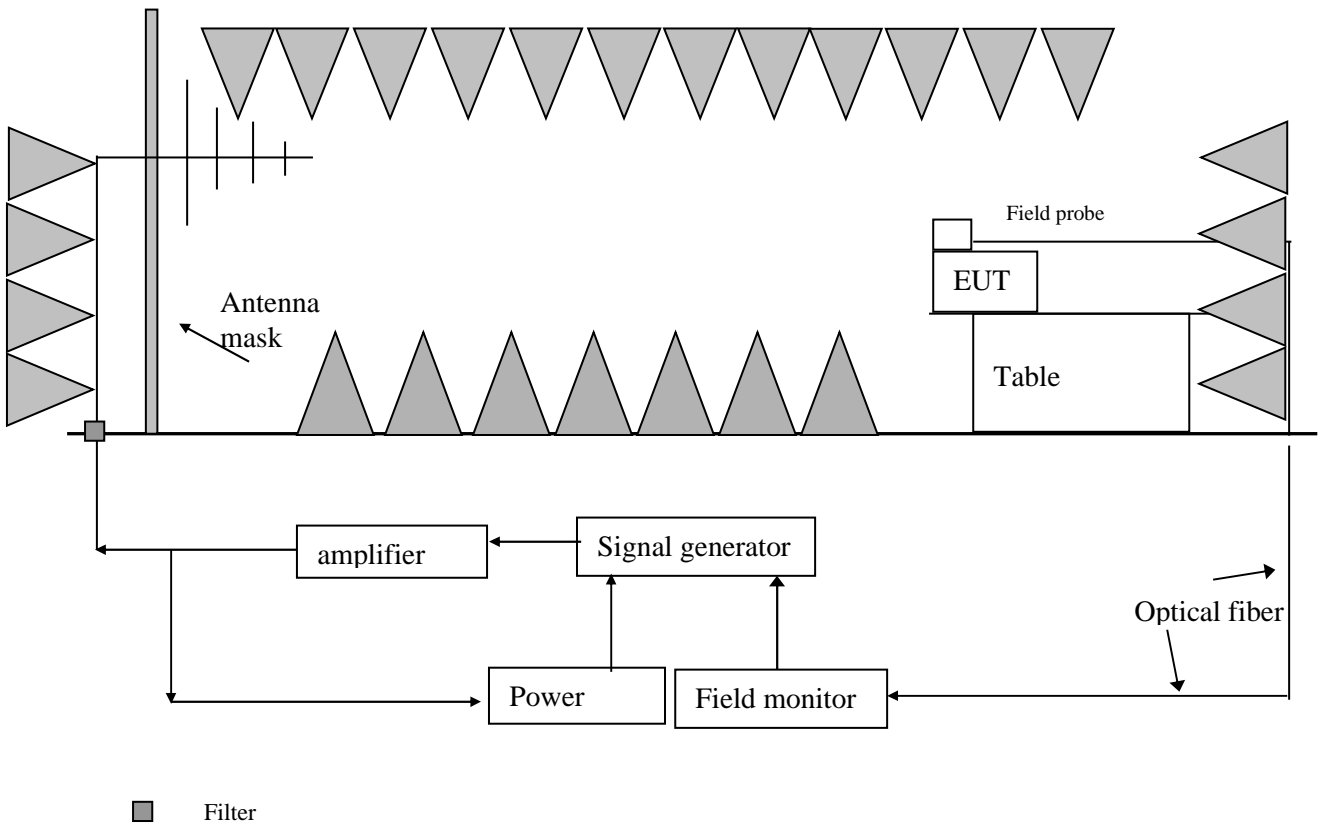

TEST REPORT

8.6.2 Test Setup and Procedure

The test was conducted in a fully anechoic chamber to maintain a uniform field of sufficient dimensions with respect to the EUT, and also in order to comply with various national and international laws prohibiting interference to radio communications.

The equipment was placed in the test facility on a non-conducting table 0.8m high (for floor standing EUT, is placed on a non-conducting support 0.1m height).

The EUT was placed on the uniform calibrated plane which is 3V/m and 1V/m EM field.

For all ports connected to EUT, manufacturer specified cable type and length was used, for those cables no specification, unshielded cable applied. Wire was left exposed to the electromagnetic field for a distance of 1 m from the EUT.

The EUT was arranged and connected according to its functional requirements

Before testing, the intensity of the established field strength had been checked by placing the field sensor at a calibration grid point, and with the field generating antenna and cables in the same positions as used for the calibration, the forward power needed to give the calibrated field strength was measured. Spot checks was made at a number of calibration grid points over the frequency range 80 to 1000 MHz and 1.4 to 2.7 GHz, both polarizations was checked. After calibration, the EUT was initially placed with one face coincident with the calibration plane.

The frequency range was swept from 80 to 1000MHz and 1.4 to 2.7 GH, with the signal 80% amplitude modulated with a 1 kHz sinewave, pausing to adjust the r.f. signal level. The dwell time at each frequency was 3s so as that the EUT to be exercised and be able to respond.

The step size was 1% of the fundamental with linear interpolation between calibrated points. Test was performed with the generating antenna facing each of the four sides of the EUT.

8.6.3 Test Result

Frequency (MHz)	Exposed Side	Field Strength (V/m)	Result
80 to 1000	Front	3 V/m (r.m.s.)	Pass
80 to 1000	Left	3 V/m (r.m.s.)	Pass
80 to 1000	Rear	3 V/m (r.m.s.)	Pass
80 to 1000	Right	3 V/m (r.m.s.)	Pass

TEST REPORT

Frequency (MHz)	Exposed Side	Field Strength (V/m)	Result
1.4 to 2.0	Front	3 V/m (r.m.s.)	Pass
1.4 to 2.0	Left	3 V/m (r.m.s.)	Pass
1.4 to 2.0	Rear	3 V/m (r.m.s.)	Pass
1.4 to 2.0	Right	3 V/m (r.m.s.)	Pass

Frequency (MHz)	Exposed Side	Field Strength (V/m)	Result
2.0 to 2.7	Front	1 V/m (r.m.s.)	Pass
2.0 to 2.7	Left	1 V/m (r.m.s.)	Pass
2.0 to 2.7	Rear	1 V/m (r.m.s.)	Pass
2.0 to 2.7	Right	1 V/m (r.m.s.)	Pass

TEST REPORT

8.7 EN 61000-4-8(Pursuant to EN 61000-6-1) Power Frequency Magnetic Field Immunity

Tested Port: Enclosure

Performance criterion: A

8.7.1 Block Diagram of Test Setup

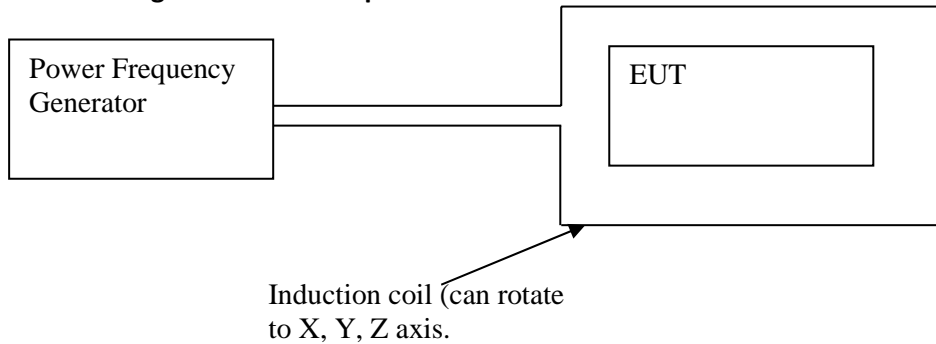

8.7.2 Test Setup and Procedure

Put EUT into center of induction coil (with suitable dimensions) in the testing.

For tabletop equipment:

The EUT was placed on a big enough wooden desk with height of 0.8m and operating as intended.

The equipment shall be subjected to the test magnetic field by using the induction coil of standards (1m*1m).

The induction coil shall be rotated by 90° in order to expose the EUT to the test field with different orientations.

For Floor-standing equipment:

The EUT was placed on big enough wooden desk with height of 0.1m and operating as intended.

The equipment shall be subjected to the test magnetic field by using induction coils of suitable dimensions; the test shall be repeated by moving and shifting the induction coils, in order to test the whole volume of the EUT for each orthogonal direction. The test shall be repeated with the coil shifted to different position along the side of the EUT, in steps corresponding to 50% of the shortest side of the coil.

The induction coil shall then be rotated by 90° in order to expose the EUT to the test field with different orientations and the same procedure followed.

TEST REPORT

8.7.3 Test Result

Mains frequency: 50 Hz

60 Hz

Orientations of induction coil	Magnetic Field Strength (A/m)	Result
X	3 A/m	Pass
Y	3 A/m	Pass
Z	3 A/m	Pass

TEST REPORT

9. APPENDIX II – PHOTOS OF EUT



Overall view



Bottom view

TEST REPORT



Internal view of EVVO 8000TL3P, EVVO 10000TL3P, EVVO 12000TL3P



Internal view of EVVO 3000TL3P, EVVO 4000TL3P, EVVO 4800TL3P,
EVVO 5000TL3P, EVVO 6000TL3P

TEST REPORT



Internal bottom



Earthing terminal

TEST REPORT



Component side of main board

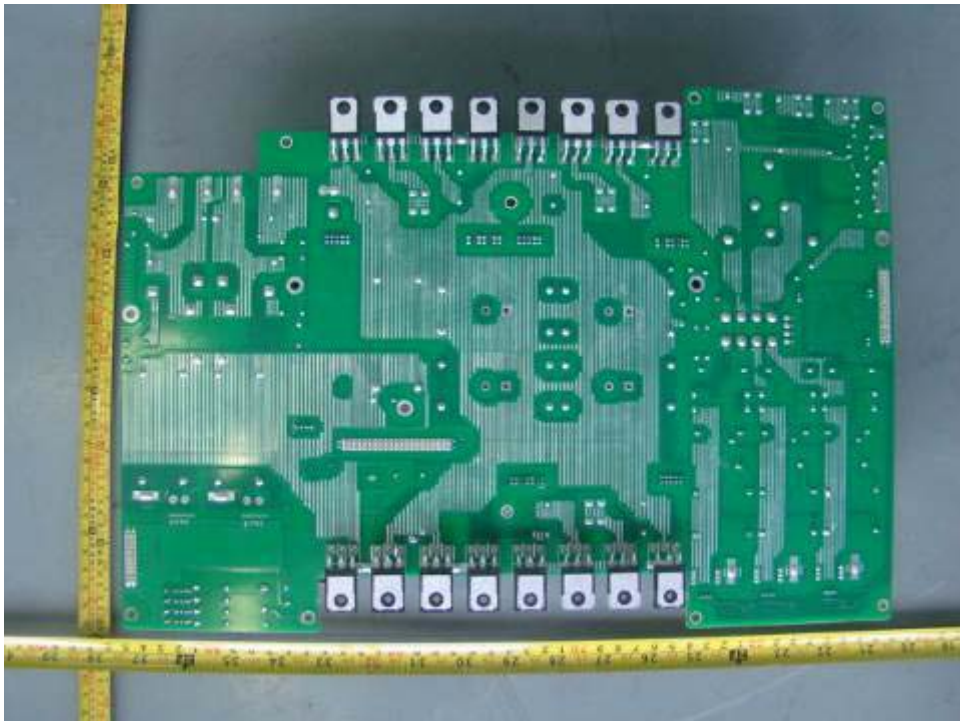

Trace side of main board

TEST REPORT

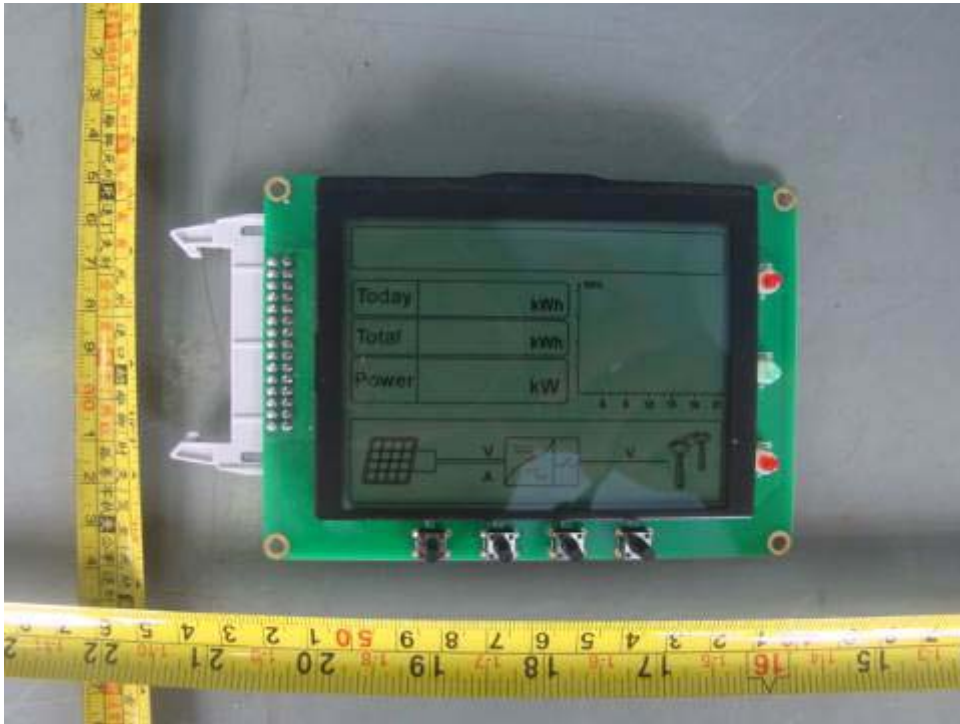

Component side of LCD board

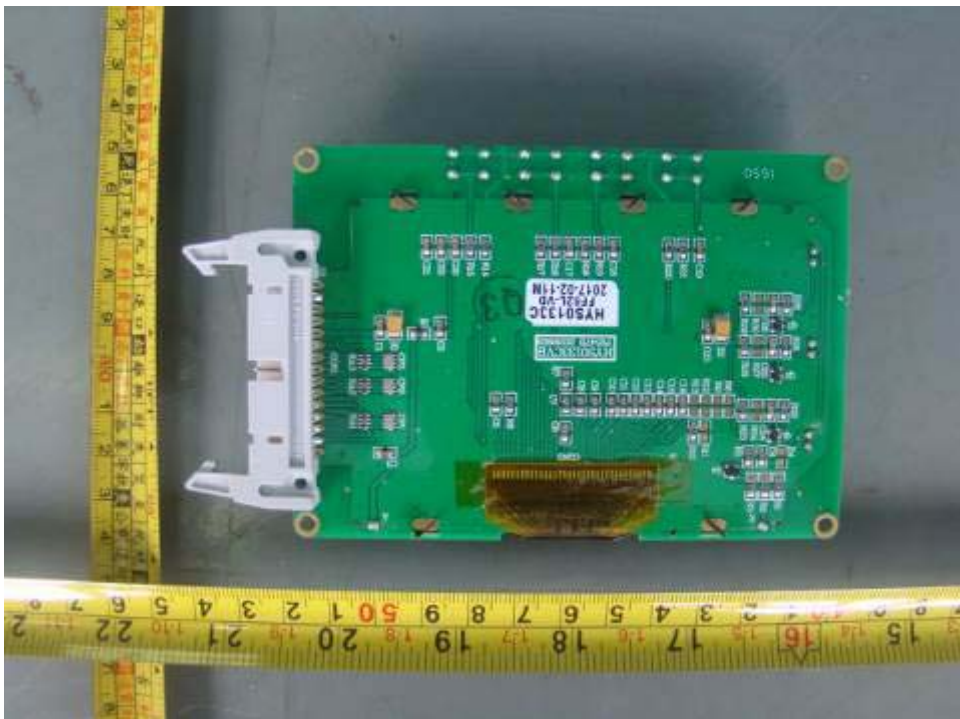

Trace side of LCD board

TEST REPORT



Component side of control board



Trace side of control board

TEST REPORT



Component side of COM board

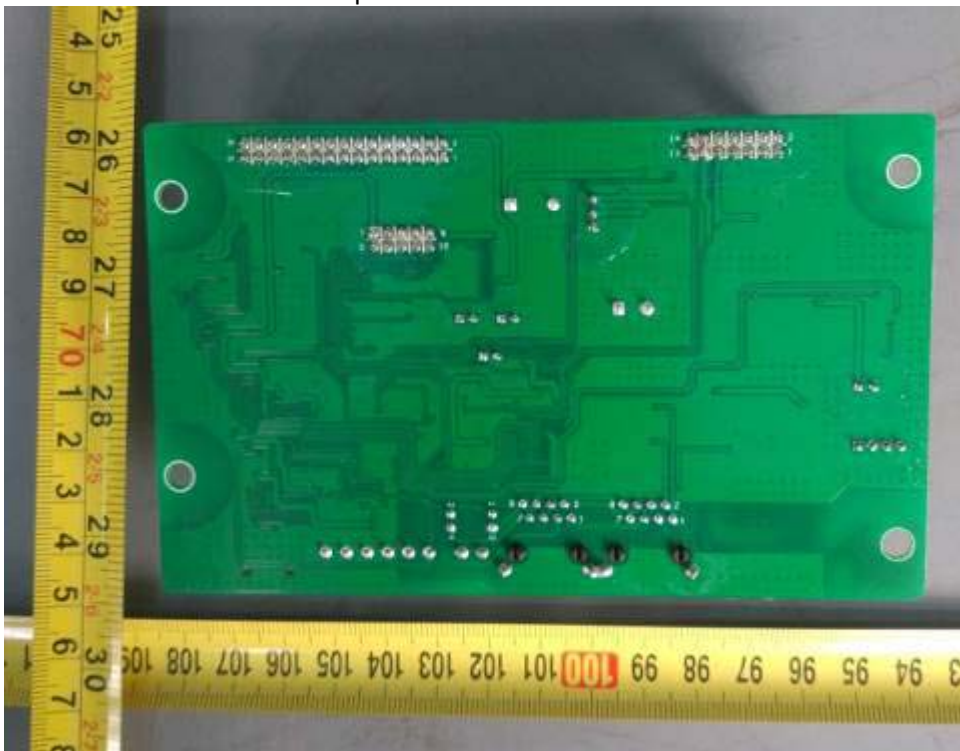

Trace side of COM board

*****End of Report*****